

COMMUNITY BASED OPERATION AND MAINTENANCE MANAGEMENT GUIDELINE HAS 8 PARTS

PART - A INTRODUCTION TO O&M MANAGMENT

PART- B DESCRIPTION OF WATER SOURCES AND TECHNOLOGIES

**PART - C TECHNICAL OPERATION AND MAITENANCE
REQUIRMENTS**

PART - D RURAL WATER SUPPLY SCHEMES MANAGMENT

PART - E RURAL WATER UPPLY SPARE PARTS MANAGMENT

PART - F M&E AND REPORTING SYSTEM

PART - G WATER SUPPLY SAFETY PLAN

PART - H PREPARATION OF ACTION PLAN

Community Based Operation and Maintenance Management Manual for Rural Point Water Supply Schemes: Part-C - Technical O&M Requirements

Draft Manual

Table of Contents

List of Tables	ii
List of Figures	ii
List of Annexes	iii
3. TECHNICAL REQUIRMENTS FOR OPERATION AND MAINTENANCE	1
3.1 General	1
3.2 Causes of Failures of Water Supply Schemes	1
3.3 Factors Affecting Sustainable O&M Management	2
3.4 O&M Requirements for Hand- Dug Well	4
3.4.1 Maintaining Well Sites	4
3.4.2 Involving the Community	5
3.4.3 What to Do If Your Well Dries Up	5
3.4.4 Make Sure the Well is Clean	7
3.5 O&M Requirements of Shallow Well	7
3.6 Hand Dug Well and Shallow Well fitted with Hand Pump	7
3.6.1 The Hand Pumps	7
3.6.2 Types of Hand Pumps	8
3.6.3 O&M Activities for Hand Pumps	9
3.6.4 Maintenance of Afridev Hand Pump	9
3.6.4.1 Components of the Hand Pump & their Functions (AFRIDEV)	9
3.6.4.2 Steps in Maintenance of Afridev Hand Pump	12
3.6.4.3 TASKS OF CARETAKERS	12
3.6.4.4 Routine Maintenance of Afridev Hand Pump	19
3.6.4.5 Tools and Spare Parts required for Handpump Maintenance	20
3.6.4.6 SOLVE MINOR PROBLEMS	21
3.6.4.7 Keep Tools and Parts	22
3.6.4.8 Keep Records	23
3.6.4.9 Use the Pump Properly	23
3.6.4.10 Everyone is a CARE-taker	25
3.6.5 Indian Mark – II Hand Pump	26
3.6.5.1 Components of the Hand Pump & their Functions (India Mark II)	26
3.6.5.2 General Maintenance Schedule	28
3.6.5.3 Maintenance Procedure	32
3.6.5.4 Routine Maintenance	33
3.6.5.5 SOLVE MINOR PROBLEMS	33
3.6.5.6 GET HELP WITH MAJOR PROBLEMS	34
3.6.5.7 KEEP TOOLS AND PARTS	35
3.6.5.8 KEEP RECORDS	35
3.6.5.9 Use the Pump Properly	36
3.6.5.10 Everyone is a CARE-taker	37

3.6.6	Troubleshooting – Causes and Remedies	39
3.6.7	Rope Pump	41
3.6.7.1	The advantage and disadvantage of the Rope pump	42
3.6.7.2	Various Rope pump models	42
3.6.7.3	General data of the Rope pump	43
3.6.7.4	Operation of Rope Pump	43
3.6.7.5	Regular maintenance	44
3.6.7.6	Other Maintenance Requirements	45
3.6.7.7	Operation- and Maintenance sheet	45
3.6.7.8	Description of O&M Activities for Rope Pump HDW	46
3.6.8	O&M Resources for Had Dug Well	47
3.7	Spring Collection Chambers	48
3.7.1	Description of O&M requirement for On-Sport Spring	48
3.7.2	Maintenance Schedule	48
3.7.2.1	Organise Your Work	48
3.7.2.2	Work with the WUC/WaSHCO	49
3.7.2.3	Inspect the Spring Box, Reservoir, Tap Stand and Site	50
3.7.2.4	Routine Maintenance	54
3.7.2.5	Solve Minor Problems	54
3.7.2.6	Get Help with Major Problems	55
3.7.2.7	Keep Tools and Parts	56
3.7.2.8	Keep Records	57
3.7.3	Proper Use of the Developed Spring	57
3.7.4	Get the Community Involved	58
3.8	Preventive Maintenance	58
3.9	Unscheduled Maintenance	58
3.10	Health and Environmental Requirements	59
3.10.1	Hygienic Operation and Use	59
3.10.2	Household Hygiene	59
3.10.3	Environmental Hygiene	60
Annexes		61

List of Tables

Table 3-1: Critical factors affecting O&M Management	2
Table 3-2: Comparison between Indian Mark-II and Afridev Hand Pumps	8
Table 3-3: Component of an Afridev Hand Pump	10
Table 3-4: Example of maintenance record keeping format	23
Table 3-5: Feature of an Indian Mark-II Hand Pump	26
Table 3-6: Schedule of spare parts for Indian Mark-II handpump	35
Table 3-7: Example of Maintenance record keeping format for Indian mark-II handpumps	36
Table 3-8: Trouble shooting for Afrideve	39
Table 3-9: Trouble shooting for India Mark II	40
Table 3-10: others rope pump maintenance requirements	45
Table 3-11: Summary of O&M Requirement for Spring Protection	52
Table 3-12: O&M of Spring Box	53
Table 3-13: Solving Minor Problems for Spring Box	55
Table 3-14: Spring Chamber Maintenance Sheet	57

List of Figures

Figure 3-1: Conceptual Framework for Sustainable O&M Management	3
Figure 3-2: Components of Well Site to be cleaned	4
Figure 3-3: Involvement of Community in Site Cleaning	5

Figure 3-4: Deepening the Hand-Dug Well	6
Figure 3-5: 3-D of Hand-Dug well fitted with Hand Pump	6
Figure 3-6: Cross-section of the upper and the Cylinder of the Afridev Pump	11
Figure 3-7: Details of Afridev Hand Pump	12
Figure 3-8: Pictorial demonstration of Weekly hand pump inspection	16
Figure 3-9: Pictorial shows stroke test	18
Figure 3-10: Lists of Fast moving spare parts	20
Figure 3-11: Basic Tools required for handpump maintenance	21
Figure 3-12: schedule of spare parts for Afridev handpump	22
Figure 3-13: Cross-section of the upper part of Indian Mark-II	27
Figure 3-14: Details of Indian Mark -II Hand Pump	28
Figure 3-15: graphic demonstration of the weekly Inspection of the pump	29
Figure 3-16: Pictorial demonstration for stroke test for Indian Mark-II handpump	30
Figure 3-17: Pictorial demonstration for bucket test for Indian Mark-II handpump	31
Figure 3-18: Typical Rope Pump	41
Figure 3-19: AB and AH Model Rope Pump	43
Figure 3-20: Typical Feature of On-Spot Spring Box	52
Figure 3-21: Typical Plan of Spring Development with Spring Box	53

List of Boxes

Box 1: Procedures for organizing the community for site cleaning by the caretakers	5
Box 2: Major Tasks of Caretakers	13
Box 3: Caretakers Report content	14
Box 4: Checklist for Weekly Inspection of hand pumps	15
Box 5: Checklist for monthly inspection of handpumps	17
Box 6: Procedure for stroke test	17
Box 7: Procedure for bucket test	18
Box 8: Rules for proper utilization of schemes	24
Box 9: Checklist for weekly inspection of Indian Mark-II hand pump	29
Box 10: Checklist for Monthly Inspection of Indian Mark-II hand pump	30
Box 11: Checklist for Annual Inspection of Indian Mark-II hand pump	32
Box 12: Daily Activities for rope pump HDW	46
Box 13: Monthly Activities for rope pump HDW	47
Box 14: Annual Activities for rope pump HDW	47
Box 15: Caretakers task for the spring water sources	48
Box 16: Caretaker report contents to WASHCO	49
Box 17: Lists of Spring Box, Reservoir and Public Water point Inspection	50
Box 18: Procedures for Routine Maintenance of Spring Box	54
Box 19: Typical hygienic rules for users	59

List of Annexes

Annex A: Afridev Hand Pump Maintenance and Repair Sheet	61
Annex B: Weekly and monthly Inspections Sheet	66
Annex C: Maintenance Record Sheet	68
Annex D: Details of Indian Mark-II, Extra Deep and Mark-III	69
Annex E: Indian Mark-II Hand Pump Maintenance and Repair Sheet	70
Annex F: Monthly check sheet for spring Type-1	78
Annex G: Monthly check sheet for spring Type-2	79
Annex H: Monthly check sheet for spring Type-3	80

Left blank

3. TECHNICAL REQUIRMENTS FOR OPERATION AND MAINTENANCE

3.1 General

This part deals with what is required for a water supply to function in the long term. The requirements are broader, but this guideline focuses on the hand dug well, shallow well fitted with handpumps and on-spot spring.

The purpose of this guideline is to give an overview of the roles and responsibilities of WASHCOs, Area Mechanic, caretakers and community in O&M management of inspection, day to day operation and preventive maintenance to be carried out for low technology options.

This guideline is divided into three sections. The first section covers operation and maintenance of Hand Dug Wells fitted with Afridev, Indian Mark-II and Rope Handpumps, and the second section covers operation and maintenance of Shallow wells fitted hand pumps and the third section deals with the operation and maintenance of Spring Developments.

3.2 Causes of Failures of Water Supply Schemes

Assessment of existing situation of the rural water supply schemes was conducted prior to the preparation of this manual. One of the methods of the assessment was conducting key informant interviews at MoWE and four major regional Water Bureaus. According to the findings, the causes of failure of the rural water supply schemes are the following:

- Inappropriate design of water supply schemes: Poor design is often compounded by inadequate supervision of construction, Poor construction quality and workmanship. Digging HDW in wet season mislead the yield of the wells, consequently, it would dry up during the dry period,
- A focus on new schemes construction and expansion by government and NGOs and Donors that neglects the maintenance of existing water supply schemes,
- There are often inadequate data recording for planning O&M. Data are required, for example, on the cause of breakdowns and the maintenance and repair costs involved. O&M can then be planned based on field experience,
- A lack of training and understanding of maintenance procedures leads to the poor performance of O&M staff (operators, mechanics, caretakers, etc.),
- The lack of human resources capacity at all level and poor financial management, this issued pronounced in Woreda level,
- Lack of contribution of money by the community. Communities, especially who use low technology facilities do not pay for the water they use,
- Lack of community involvement and subsequent sense of ownership,
- Poor community organization or cohesion; lack of follow-up support and/or training; the unavailability or high cost of spare parts,
- No functional supply chain exists. The existing supply chain is in fragmented way. World Bank was commenced a comprehensive supply chain for hand pumps supply but still not functional,

- Although various O&M manuals, exists, which developed by GTZ, UNICEF, ESRDF, UNDP, World Bank, WaterAid and other NGOs, most of the water supply schemes managed without adapting those already developed manuals,
- Private sectors involvement in spare part provision is very less even if the water policy stated their participation. The World Bank financed WaSH program was tried to address the private sector involvement like LSP, WSG, CFT etc, but now is not functional,
- Provision of incentive for WaSHCOs is absent to encourage the members to work actively,
- The Health and Agricultural sector established link among the kebele and federal level, like Health Extension Workers (HEWs) and Development Agents (DAs), but for the water sectors such set up does not exists, which have negative implication in sustainability of the schemes. People came from TVET, do not get further training to capacitate them.
- Appropriate budget do not allocated for O&M.
- Money management by the WASHCOs is poor, they have not audited, as a result the collected money abused,
- Region/Zone/Woreda water offices execute maintenance work upon request and provide back up support when funding is available. It is difficult to prioritize O&M given that financial resources are so limited particularly for multi village and motorized schemes,
- Legal framework for local community for establishing WASHCO association, putting in place enabling laws is a good start to reinforce community management and accountability,

3.3 Factors Affecting Sustainable O&M Management

The most appropriate operation and maintenance strategy for a particular supply will depend on a range of factors:

Table 3-1: Critical factors affecting O&M Management

No.	Factors	Description
1	Technology	complexity, familiarity, standardization, spares availability and skills required
2	Demography	scattered or dense population; numbers of people served
3	Environment	effect on the water source; effect on materials and equipment
4	Accessibility	main road or remote water supplies
5	Cost	Total cost of O&M and the cost per individual user - what are users willing and able to pay?
6	Management	level of community organization and cohesion; existing management structures and skills; efficiency of support agency management

6	General economy and level of development	inflation; stability of prices; fluctuation in incomes; availability of skills, tools, equipment and services
7	Government policy and legal framework	Government-promoted O&M strategies; legal ownership; accountability and the allocation of responsibilities.

The above listed bullets are the major constraints for the sustainable O&M management. In conceptual framework it can be demonstrating with the following picture.

Figure 3-1: Conceptual Framework for Sustainable O&M Management

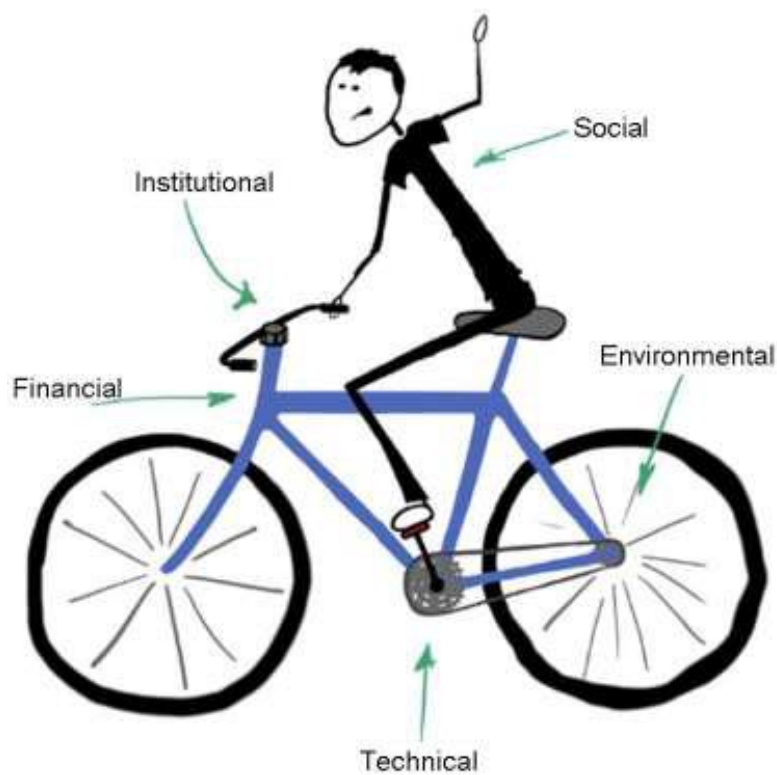

A bicycle has been used to illustrate that components of sustainability depend upon each other; for a bike to work effectively, it needs a frame, handle bars, wheels, a crank and chain, and someone to ride it. Without any one of these, the bike will not work as it should.

For sustainability, the social, financial, technical, institutional and environmental components must also be in place and working effectively. If there are deficiencies or failures in any of the components, sustainability of the water supply schemes will be compromised. Components of the bike are not analogies for components of sustainability; there are not particular characteristics of a wheel that make it inherently more representative of the environmental component than any other. What the conceptual framework portrays is the importance that all components depend upon each other in order for the system to work effectively

3.4 O&M Requirements for Hand- Dug Well

3.4.1 Maintaining Well Sites

A hand dug well/shallow well sites that is in good condition will ensure that handpump users can get water easily and safely. On the other hand, if the site is in bad condition, the handpump will become damaged, the water in the well could become contaminated from external pollutants and people could become sick from using the water from the well.

There are a number of things that can be done to keep the hand dug well site in good condition. All the handpump users can help you to do these things.

A. Keep the Well Site Clean

- ☞ Keep the site free from mud, weeds and excess water. Sweep the concrete apron around the pump every day. Weed it when necessary, and scrub the apron and pump stand to remove green slime when it appears.

B. Drain Spilled Water away from the Well Site

- ☞ Make sure there are no pools of water around the handpump. Stagnant water will cause the area to become muddy, attract mosquitoes and pollute the well.
- ☞ Keep the drainage channel clean and open so that spilled water can drain away to the soakage pit, garden or animal trough.

C. Protect the Concrete Apron and Drainage

- ☞ When the apron and drainage channel are not protected, they will crack and disintegrate. Make sure that they are protected against animals by properly maintaining the fence. If there is a sign of erosion around the apron, protect it by piling stones around it.

Figure below shows the components of the well site that is maintained by caretaker and community.

Figure 3-2: Components of Well Site to be cleaned

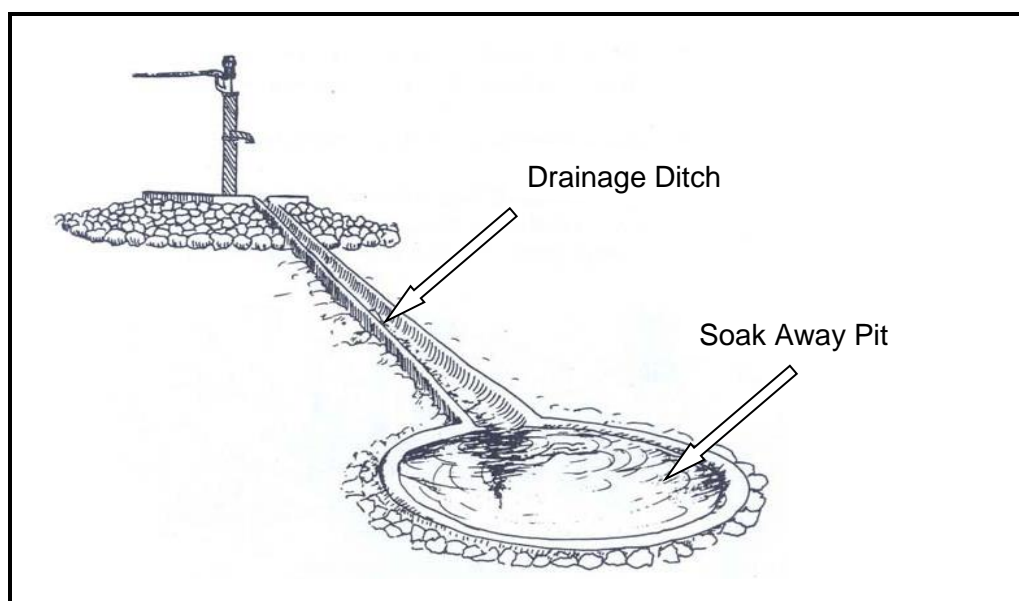

3.4.2 Involving the Community

Maintaining the pump site is the responsibility of the **WHOLE COMMUNITY**, not just the caretakers. Your job is to organize the work, not do it all yourself!

Box 1: Procedures for organizing the community for site cleaning by the caretakers

Here are some ideas for how to organize the community:

- ☞ Call a community meeting and get everyone's view about how best to organize pump site maintenance and rules about pump use.
- ☞ Divide the work of sweeping and scrubbing the apron amongst the women
- ☞ Divide the work of weeding the pump site amongst the men from different sections of the community on a rotating basis.
- ☞ Get children involved in sweeping, scrubbing and weeding.
- ☞ Organize a maintenance day at the end of the rainy season

The following pictures demonstrate the involvement of the community in site cleaning.

Figure 3-3: Involvement of Community in Site Cleaning

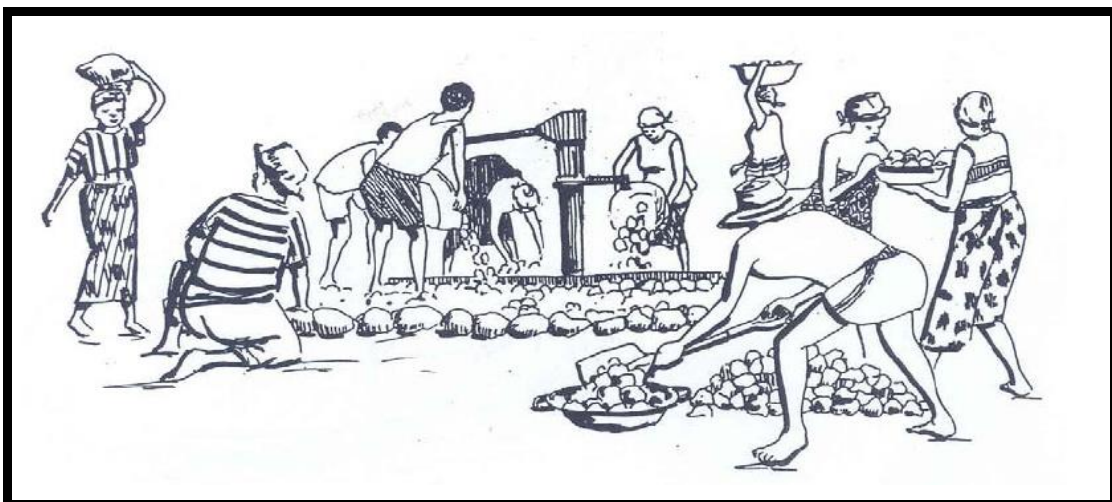

3.4.3 What to Do If Your Well Dries Up

During the first few years following the construction of the well, it is possible that it might dry up during the dry season. If this happens, it will need to be deepened.

If the well dries up or is drying up, you should:

- Contact the Woreda Water Resources Office and inform them
- Talk to the Contractor or otherwise the one who constructed the well. If it happens in the first year after construction, the one who constructed the well will return to your community and deepen the well for you at no cost.

- Assist with the deepening of the well under the direction of the Contractor.

If the well dries up more than 1 year after construction, your community may have to pay for the well to be deepened by the Contractor. You should discuss this with the Woreda Administration.

Figure 3-4 shows deepening of well when the static water level drops and lowering of the hand pump.

Figure 3-4: Deepening the Hand-Dug Well

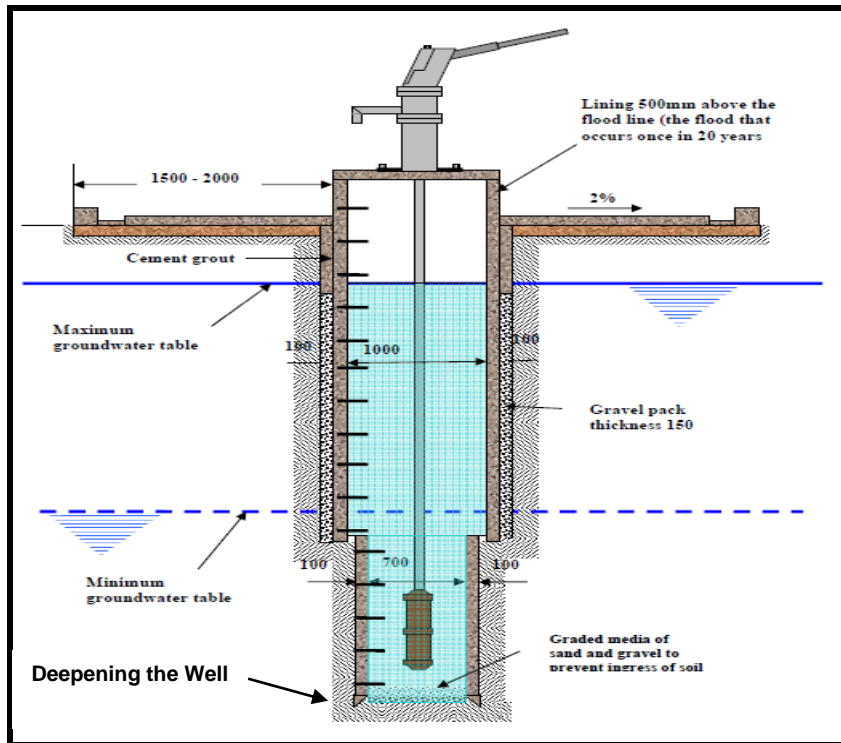
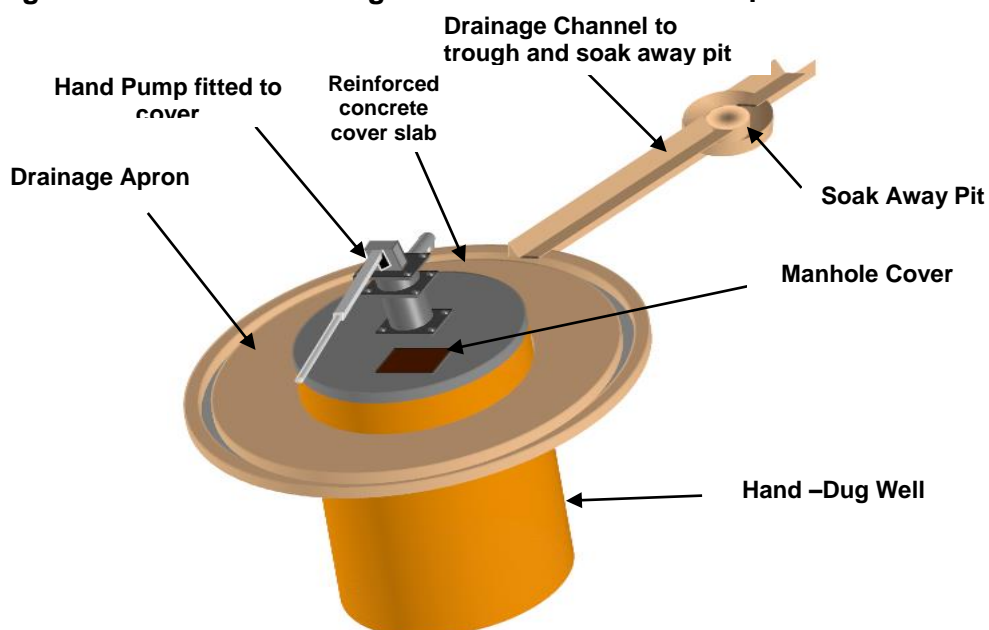

Figure 3-5: 3-D of Hand-Dug well fitted with Hand Pump



3.4.4 Make Sure the Well is Clean

If the well is deepened, or if anyone enters the well for any reason (such as cleaning it or repairing cracked well lining etc) then the well **MUST** be cleaned and disinfected before it can be used again.

The Contractor and the Woreda Water Resource Office can assist you with this.

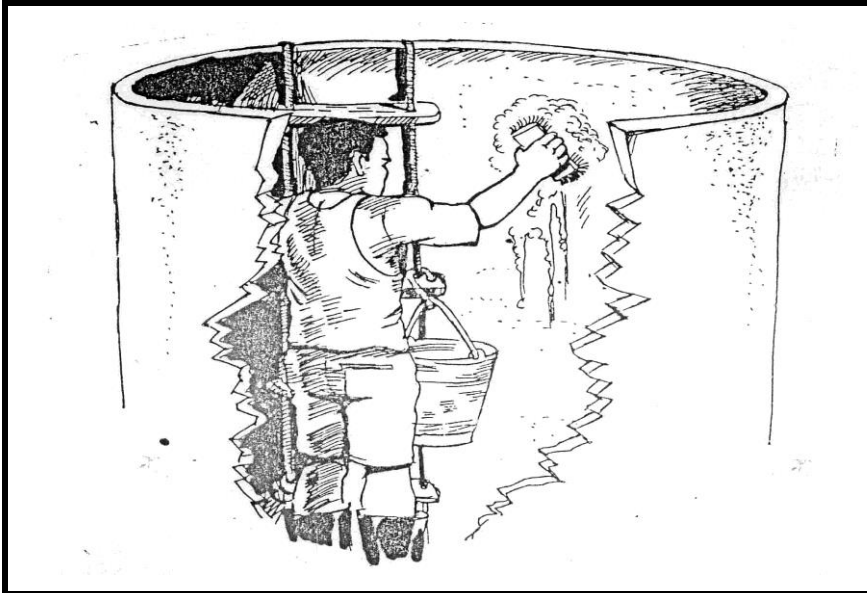

3.5 O&M Requirements of Shallow Well

Shallow drilled wells are wells which have been drilled with drilling machine and lined with uPVC or steel casing. The maximum depth of such wells is in the range of 60 m. This type of wells could be fitted with VLOM type hand pumps and the diameter of the wells is usually 4 to 6 inch. Cleaning of such well is not done manually but with the use of pumps, surging and or bailing. Thus it requires drilling machine, pumps and accessories and trained personnel. To this effect cleaning and developing of such well is done by drilling company or by the Regional Water Bureaus. Therefore, when there is a need to do such work the WaSHCO should contact the Bureaus. Regarding the maintenance of the well head and the hand pump, it is identical with the hand dug well. However, if the well is fitted with pumps such as Indian Mark II a tripod, chain block and pipe clamp is required for maintenance as during maintenance one should remove all the riser pipes. Hence, it should only be done by qualified technician.

3.6 Hand Dug Well and Shallow Well fitted with Hand Pump

3.6.1 The Hand Pumps

The hand pump is defined as a mechanical water lifting device that uses the pumping motion to extract water from the borehole or well to the surface.

Hand Dug wells and Shallow wells drilled for the use of Hand Pump is generally of 125 mm diameter size, which may be fitted with variety of Hand Pump. Boreholes may be fitted with a variety of pumps. The Afridev, India Mark II and Rope hand pumps are the most common hand pumps used in Ethiopia. The technical requirement for operation and maintenance of these hand pumps is described in this section.

Such type of pumps could be installed in wells which have a depth up to 45 m. Maintenance of such pump does not need crane as there is no need to pull out the riser pipe during maintenance. To maintain and operate the hand pump, Caretakers should know the parts of the hand pump and their functions.

3.6.2 Types of Hand Pumps

Different types of hand pumps installed in Ethiopia. However, for the purpose of this manual focuses on the AFRIDEV, India Mark - II and Rope which are the most popular hand pump in Ethiopia.

Comparison of the most popular Indian Mark-II and Afridev is illustrated in table below.

Table 3-2: Comparison between Indian Mark-II and Afridev Hand Pumps

Criteria	India Mark II	Afridev
International Specification	Specified through Indian Standards. The pump is produced in several countries to these standards. The design is in the public domain and the specifications are available to everybody.	Specified through an International Standard. The pump is produced in several countries to these standards. The specifications are in the public domain and the specifications are available to everybody.
Ease of installation	19 different tools are required for installation. Skilled crew is needed.	8 different tools are needed for installation. Skilled crew is needed.
Ease of repair (major repairs)	A trained village mechanic equipped with special tools is required. For fishing dropped components special equipment is needed.	A skilled mechanic is required for the replacement of perforated riser pipe and fishing of dropped rods. Retrieval of PVC pipes and rejoining them in the field needs proficiency and special equipment
Reliability	Reliable in non-corrosive water with few breakdown interventions.	Reliable, but frequency of maintenance interventions will be comparatively higher due to preventive maintenance requirements. Reliability can suffer badly if used in unlined borewells. When breakdowns occur, in most cases, it can be repaired quickly by the village mechanic. However results from the field indicate that the PVC rising main can fail if they are in contact with the rods.
Corrosion resistance	Galvanized rising mains and carbon steel galvanized rods are not corrosion resistant in water with pH values below 6.5. Stainless steel pipes are available but at a very high cost and are not standard to the specification. Corrosion resistant stainless steel rod option available is standard to the specification.	All below ground components including rising main are corrosion resistant with the exception of galvanized pump rods. Corrosion resistant stainless steel rod option available is standard to the specification.
Abrasion resistance	Riser main and rods have shown excellent abrasion resistance in non-corrosive water. The ball bearings generally last for 3-4 years. The introductions of nitrile rubber cup seal in place of leather cup seals reduce the frequency of below ground repairs by over 50%.	The bearings and the seal have a service life of about one year, but they are less expensive and easy to replace. Rubber centralizers prevent the rods coming in contact with the PVC pipes. They need regular replacement. Hook and eye connectors on the rods are subject to wear and frequent replacement of rods may be expected. Riser main perforation can

Criteria	India Mark II	Afridev
		reach unacceptable levels when used in unlined bore wells.
Suitability for unlined borewells	Can be installed in unlined bore wells.	Should not be installed in unlined bore wells because to avoid corrosion and clogging of foot valve.
Suitability for local manufacture	Asia. Can be produced in a country where industrial infrastructure for steel fabrication, hot dip galvanizing, electro-galvanizing, ferrous and nonferrous foundry and galvanized steel pipes and familiarity with quality control practices and mass production techniques exist. A substantial investment has to be made in tooling.	It is manufactured in Africa and Asia. Can be produced in a country where industrial infrastructure for steel fabrication, hot dip galvanizing, electro-galvanizing, extrusion of uPVC pipes and molding of nylon/polyacetal components and familiarity with quality control practices and mass production techniques exist. A substantial investment has to be made in tooling. The production of the plastic components requires special skills and extensive tooling.
Pumping lift	Can be used up to 45m, extra deep well version for over 45m available.	Can be used up to 45m.

3.6.3 O&M Activities for Hand Pumps

The maintenance of hand pump is identified in two categories.

a) Minor Repairs

The repairing of hand pump which does not require lifting of hand pump assembly is treated as minor repair. The minor repairs of hand pump may be made by a semi-skilled care taker/WaSHCOs. This type of repairing involves replacement of handle nut & bolts, repairing of chain, bearing etc.

b) Major Repairs

The repairing of hand pump which involves un-lowering of hand pump assembly is treated as major repairing; this type of repairing cannot be made by WaSHCOs and Caretakers and will be carried out by area mechanics/private sectors wherever available. Wherever these area mechanics/private sectors are not available either special training shall be organized by Woreda/Zone/Region Water Bureaus or out sourced.

3.6.4 Maintenance of Afridev Hand Pump

The Afridev Hand Pump is suitable for lifting water up to depth of 45 m very easily. Though, it also works as more as up to 60m but it needs then more maintenance and care. It is suitable for boreholes with casing size of nominal 100mm, 127mm or 200 mm of internal diameter and hand Dug Well.

The AFRIDEV is a true Village Level Operation and Maintenance (VLOM) pump. All the internal moving components can be withdrawn without the necessity of removing the rising main. Pump Caretakers are trained to remove the internal components and replace fast wearing parts.

3.6.4.1 Components of the Hand Pump & their Functions (AFRIDEV)

Table 3-3 below describes each component of the AFRIDEV pump. Please refer to the illustrations after the table for ease of understanding:

Table 3-3: Component of an Afridev Hand Pump

Components	Features
Pump Head	<ul style="list-style-type: none"> ▪ The mechanism above pump stand ▪ Sturdy mild steel box containing the handle pivot ▪ Spout length option of 580 mm to 300 mm ▪ Pump handle made from telescopic handle (hot dip galvanized) pump with special hexagonal bolt. Adjustable T-bar handles to reduce pumping effort. ▪ Welded and hot dip galvanized removable steel cover to protect bearing and object from falling in ▪ Tamper-proof, captive fasteners. Prevents loss and unauthorized interference
Pump Stand	<ul style="list-style-type: none"> ▪ Three pump stand options <ol style="list-style-type: none"> 1. Pump stand with bottom flange 2. Pump stand with 3 legs 3. Pump stand with ISO flange arrangement ▪ Provides hygienic seal and robust design
Rising Main Pipe	<ul style="list-style-type: none"> ▪ uPVC rising main Lightweight, corrosion ▪ uPVC rising main diameter 63 mm OD with bell sockets in 3 m lengths ▪ Other option is uPVC rising main with “Bell end” in 2.9 m lengths ▪ Carries water from cylinder to the water tank ▪ The uPVC pipes are solvent cement joint ▪ Rubber stabilizer to centralize Rising main ▪ Rubber Centralizer to Cement pump rod in rising main reduces wear of rising main ▪ Rope to hold up riser pipes to the steel cone
Cylinder Arrangement	<ul style="list-style-type: none"> ▪ Brass plunger with brass foot valve or brass plunger with plastic foot valve ▪ Plastic plunger with stainless steel fitting for corrosive resistant ▪ uPVC cylinder with brass liner to provide resistance to wear ▪ Foot valve. Easily removable without disturbing the pump head cylinder, cylinder or rising main
Pump Road Arrangement	<ul style="list-style-type: none"> ▪ The pump rod made from three option pipe materials – mild steel, stainless steel or fibre reinforced plastic ▪ Mild steel pump rods with threaded connection ▪ Stainless steel pump rods with threaded connectors ▪ Large bore suction tube reduces inlet velocity and intake of sand

Figure 3-6 indicates basic parts of the hand pump, thus; Caretakers can use the pictures below and match it against the actual parts of the pump itself. Figure 3-7 is also shown detail parts of the Afridev pump.

Figure 3-6: Cross-section of the upper and the Cylinder of the Afridev Pump

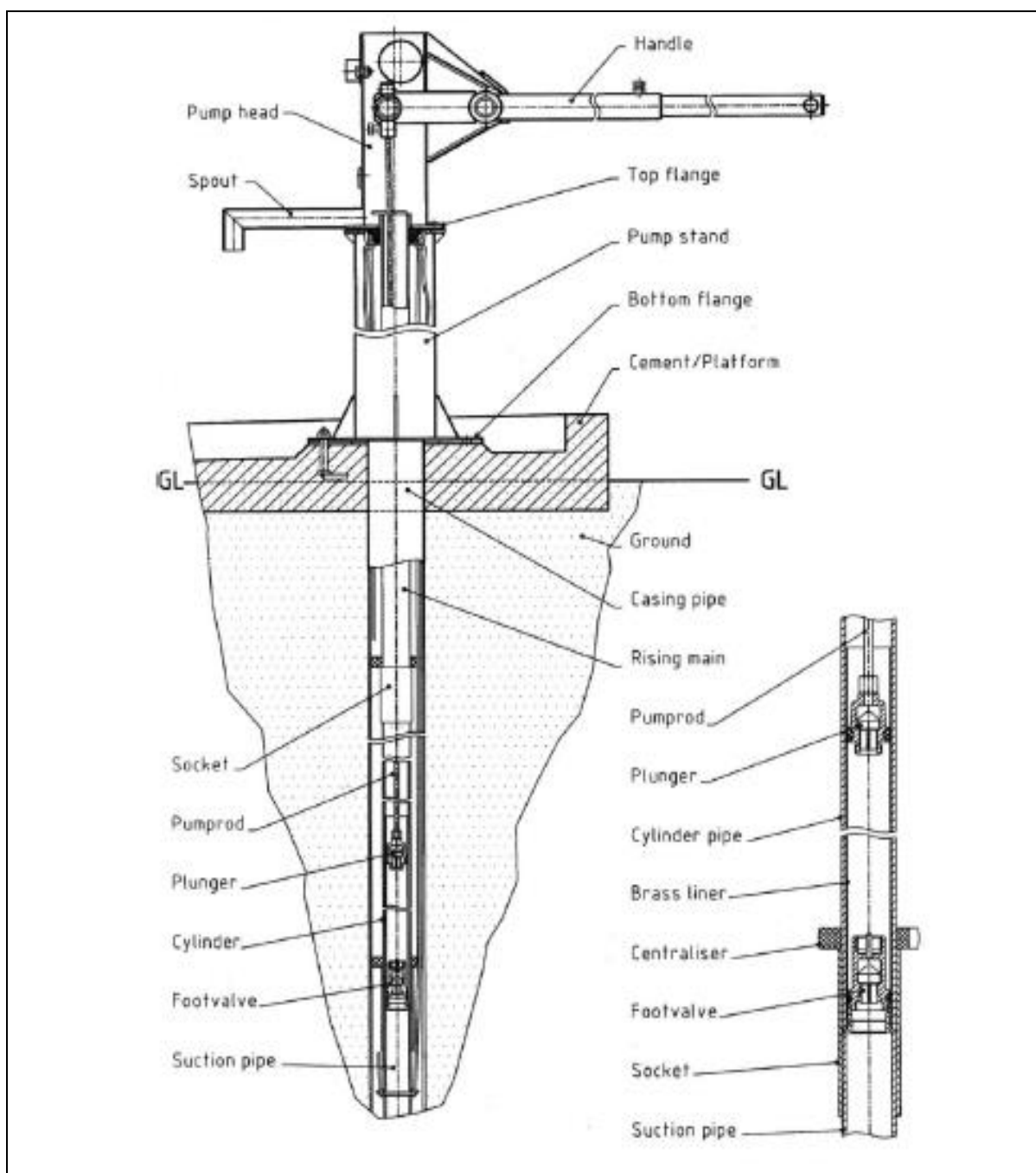
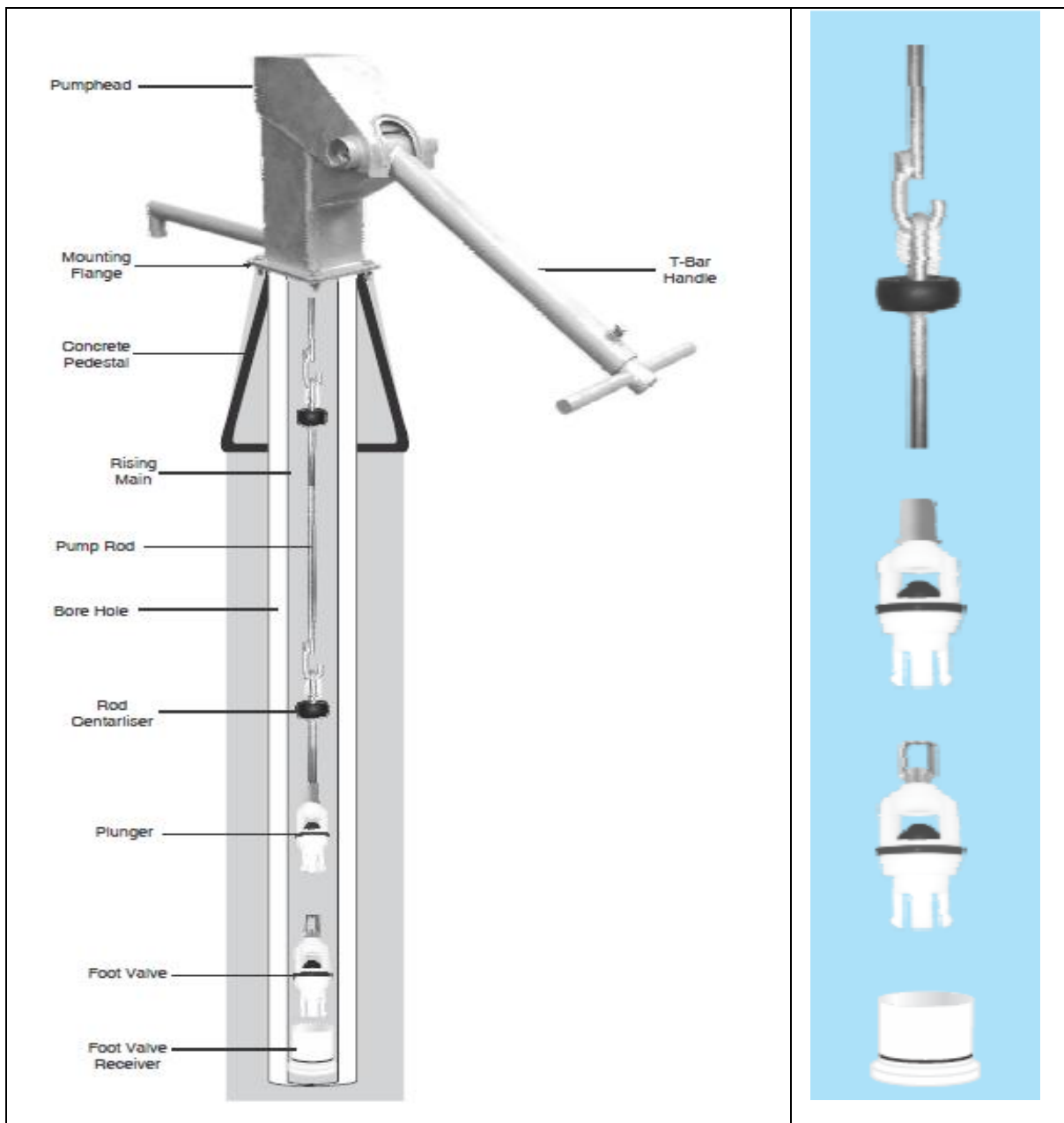

Figure 3-7: Details of Afridev Hand Pump

3.6.4.2 Steps in Maintenance of Afridev Hand Pump

The steps involved in maintenance are to:

- Understand the cause for a problem and determine the remedy need,
- Dismantle the pump as necessary,
- Assemble the pump after replacing defective components,
- Record details in the "Maintenance card"

3.6.4.3 TASKS OF CARETAKERS

The following 10 points are the major tasks of the Caretaker of your wells and pumps:

Box 2: Major Tasks of Caretakers

- ☞ **ORGANISING THE WORK.** Talk to and work with the other caretaker(s) so that you help each other and share the work load.
- ☞ **WORKING WITH THE WUC/WaSHCO,** so that your work and theirs help keep the pump operating
- ☞ **INSPECTING THE PUMP** every week and every month
- ☞ **CONDUCTING ROUTINE MAINTENANCE** – tightens nuts and replaces worn out parts such as the U-seal, the O-ring and the bearings.
- ☞ **IDENTIFYING AND SOLVING MINOR PROBLEMS.**
- ☞ **GETTING HELP FROM THE WOREDA WATER RESOURCE OFFICE TO SOLVE MAJOR PROBLEMS**
- ☞ **KEEPING TOOLS IN GOOD CONDITION, AND BUYING & STORING SPARE PARTS**
- ☞ **KEEPING RECORDS** – of parts and repairs
- ☞ **ENSURING THE PROPER USE OF HAND PUMP and WELL**
- ☞ **INITIATING AND OR ORGANISING THE COMMUNITY FOR GENERAL SITE MAINTENANCE.**

Organise Your Work

The benefiting community has to select at least two caretakers to do the job of maintaining and caring of your hand pumps.

You should meet and decide how you are going to work together. You should decide which of you will do each task. For example, one caretaker can look after the tools and spare parts and the other caretaker can look after the records

On some tasks you should work together. For example, you should inspect the pump together on a weekly and monthly basis, and carry out repairs together. This way you can help each other.

If one of you has to go down the well to inspect the well shaft or well bottom, the other should stay at the top and make sure everything is ok.





Work with the WaSHCO

As scheme Caretaker, **YOU ARE NOT ALONE**. You don't need to do everything yourself. You are a member of the WUC/WaSHCO and you can get other members to help you.

You should attend WUC/WaSHCO meetings and let the other members know what you are doing. If they know what you are doing, they will support you when you need help.

Box 3: Caretakers Report content

At every WUC/WaSHCOM meeting you should give a report on:

- **The PUMP:** Is it working okay? What have you found when you have done your regular inspections? How is the water flow?
- **SPARE PARTS:** Do you have enough spare parts? Is it time to buy more spare parts?
- **REPAIRS:** Are there any problems with the pump? Can you repair it yourself or do you need help from the Woreda?
- **PUMP SITE:** How is the area around the pump? What needs to be done? How can it be organized?

Let the other WASHCO members know how they can help you. For example they could buy the spare parts that are needed, arrange for other community members to clean the pump site or help you remove the pump for repair.



Inspect the Pump

You should inspect the pump regularly so you see problems and solve them before they become too big. Regular checking will help to keep the pump in good working order and avoid big expenses for repairs.

You should inspect the pump every **WEEK** and every **MONTH**.

Box 4: Checklist for Weekly Inspection of hand pumps

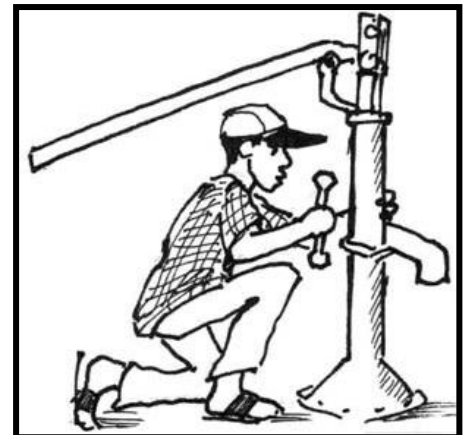

1. Weekly Inspections

Every WEEK you should check the parts on the head of the pump

- Check that the flange bolts and nuts are tight.
- Check that the Fulcrum Pin nuts and Hanger Pin nuts are tight

The following pictures demonstrate how caretakers do the weekly inspection of handpumps.

Figure 3-8: Pictorial demonstration of Weekly hand pump inspection

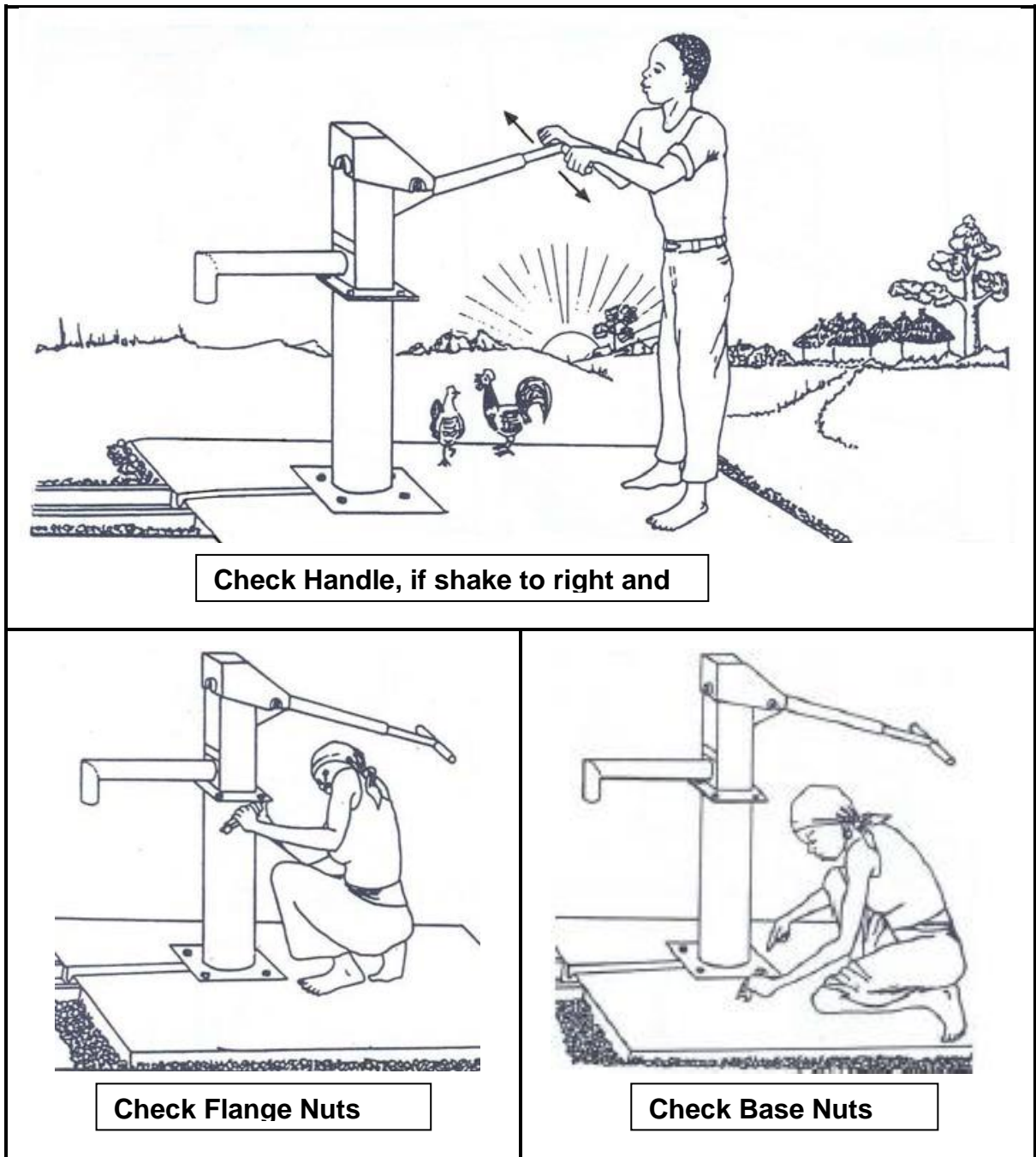

Box 5: Checklist for monthly inspection of handpumps**2. Monthly Inspections:**

- ☞ STROKE TEST – how many strokes of the pump handle until water comes?
- ☞ BUCKET TEST – how many strokes of the pump handle to fill a bucket?
- ☞ CHECK BEARINGS – are the bearings worn or broken?
- ☞ Check if any fasteners or parts in the pump head are missing. If so, replace the parts
- ☞ If any unusual noise is noticed, check reason for the same and take corrective actions.
- ☞ Check if the pump stand is shaky during operation. If yes, the stand is loose in the foundation and contamination of the well can take place. Take corrective measures to repair the foundation.
- ☞ Check if there is leakage in the pump. If more than 5 strokes are required before water comes out from the spout, it means the pump is leaking beyond an acceptable limit.
 - This needs to be attended to. It may be necessary to replace bobbin / foot valve, O-ring or attend to a leaking joint in the rising main. For attending to a defect in the rising main you may need the help of a skilled mechanic. The special leakage test can be conducted as described below.
- ☞ Carry out a “Leakage- and Discharge Test”.

STROKE/LEAKAGE TEST

Do this test early in the morning before anyone has used the pump. Count the number of full strokes before water comes. If the number of strokes increases from last month, or it takes longer than a few minutes for water to come, you should check the foot-valve.

Box 6: Procedure for stroke test**Proceed as follows:**

1. Operate the pump handle until water is flowing from the spout
2. Stop operating the pump handle for approximately 30 minutes
3. Then operate the handle and count exactly how many strokes required until the water is starting to flow again.

If more than 5 full handle strokes are required to make the water flow again, there must be a leakage in the rising main or the footvalve.

Leakage mostly occurs because of worn bobbin or o-ring of the footvalve, disconnected rising main joints or perforated or cracked riser pipes.

☞ **Report this problem immediately to the pump mechanic and ask for rectification!**

Figure 3-9: Pictorial shows stroke test

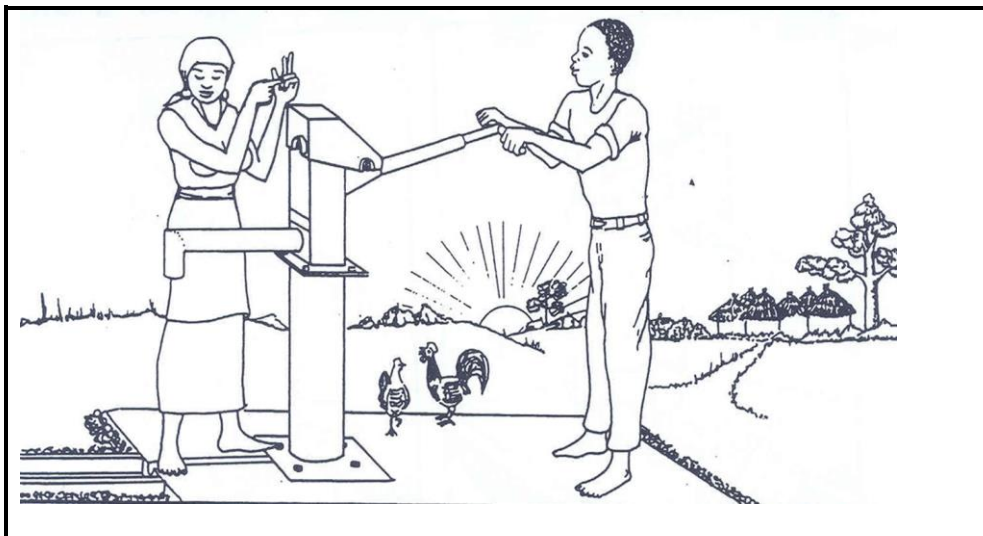

How many full strokes does it take for water to come first thing in the morning?

BUCKET/DISCHARGE TEST

Count the number of strokes to fill a bucket. You should always use the same size bucket for this test. If the number of strokes increases a lot, then change the U-seal.

Box 7: Procedure for bucket test

Proceed as follows:

1. Operate the pump handle until a continuous water flow has been achieved (pump ratio approximately 40 full strokes per minute).
2. Place a bucket in the continuous water flow for exactly one minute
3. Take the bucket off the water flow and check the amount of water drawn.

The water collected should be generally not less than 15 liters. If the discharge is less than 10 liters for 40 full strokes, there might be a problem with the bobbins or the cup seal.

☞ **Report this problem immediately to the pump mechanic and ask for rectification!**

CHECK BEARINGS

Remove the bearings to see if they are worn. Good bearings are smooth and turn easily. Worn bearings are scratched and loose. Replace worn bearings.

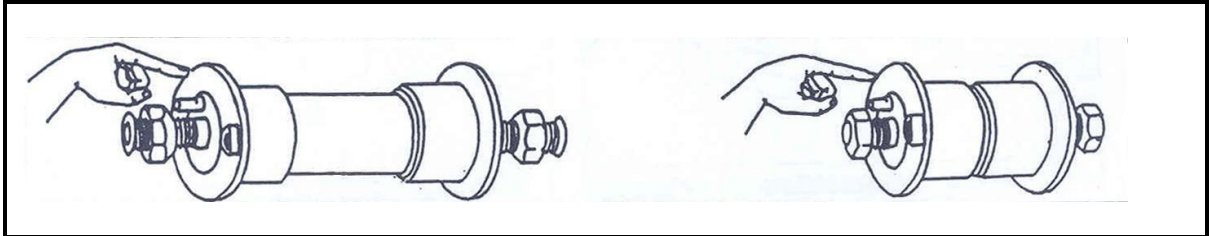

Are the bearings Spoiled?

3.6.4.4 Routine Maintenance of Afridev Hand Pump

You should do **ROUTINE MAINTENANCE** to identify and solve problems before they become big and expensive. This means tightening loose nuts, welding locker pins back on (if they have fallen off) and replacing worn out parts.

NUTS: Check that nuts are tight. However do not over tighten them – if you tighten too hard you may damage them.

LOCKER PINS: If the locker pins have fallen off, weld them back on. You may need to get help from the Woreda for this.



BEARINGS: Remove the bearings and check their condition. IF scratched, loose or uneven, replace them with new bearings. If they are okay, clean them with a rag before putting them back.

STROKE TEST: If it takes a lot of pump strokes before water comes, check the foot valve. Replace the bobbin or O-ring if they are worn. Make sure the footvalve is properly seated.

BUCKET TEST: If it takes more strokes than usual to fill a bucket, remove the plunger and check the condition of the U-seal. Change the U-seal if it is damaged or worn.

REMEMBER: If you solve a problem early, you will avoid a bigger problem later. This will save you and your community lots of time, effort and money in difficult and expensive repairs.

3.6.4.5 Tools and Spare Parts required for Handpump Maintenance

FAST MOVING SPARE PARTS

Some parts, which need to be replaced regularly, are known as FAST MOVING SPARE PARTS. These include:

- ☞ The U-Seal
- ☞ The O-ring
- ☞ The Bobbin
- ☞ The Bearings

You should buy and keep some of these parts in your village so that when they wear out or break you can replace them straight away without having to wait until someone can go and buy them.

Figure 3-10: Lists of Fast moving spare parts

2 Bearings		'U' Seal	
Bobbin		'O' Ring	

The basic tools required for hand pump maintenance are:

- a) Spanner for M16 hexagonal bolts and nuts,
- b) Fishing tool for retrieving the footvalve

For deep installations (between 30 to 45 m) with a heavy load of the pumprod assembly, the use of the Resting tool & connecting tool is advisable (this is for threaded rods only)

Figure 3-11 presents basic tools that are required for maintenance of hand pumps.

Figure 3-11: Basic Tools required for handpump maintenance

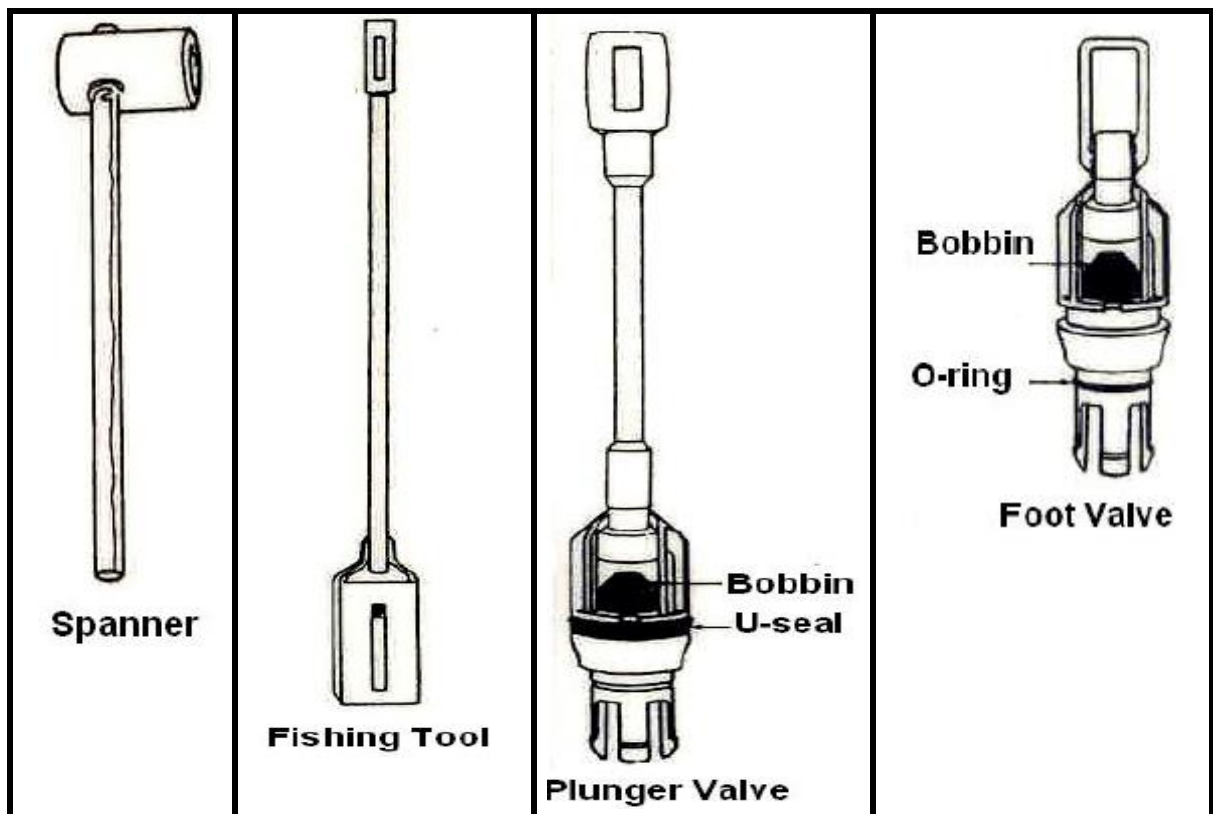

3.6.4.6 SOLVE MINOR PROBLEMS

If there are problems with your pump, you should try to solve them quickly so that they don't become bigger problems. A delay may cause more damage to your pump and cost you more to repair and the community cannot use the pump for a while. Some problems you can solve yourself. Others you may need to get help from the Woreda (Water, Mining and Energy Office) to fix.



Some common problems that you may have include:

WATER DOES NOT FLOW AT ALL

Cause	Solution
Foot valve is not in place	Check and re-seat foot valve
Bobbin is stuck or missing	Check and replace bobbin
Broken pump rods	Replace pump rods
Low water yield	Limit use of pump – deepen well

THERE IS DELAYED FLOW

Cause	Solution
Foot valve is not in place	Check and re-seat foot valve
O-ring is worn	Check and replace O-ring
Broken or leaking pipe joint	Repair joint (contact Woreda for help)

THERE IS WEAK FLOW

Cause	Solution
U-seal is damaged or worn	Check and re-seat U-seal
Broken or leaking pipe joint	Repair joint (contact Woreda for help)
Low water yield	Limit use of pump – deepen well.

THE HANDLE IS LOOSE

Cause	Solution
Fulcrum nut is loose	Tighten nut. If necessary replace fulcrum pin
Locking pin missing	Weld new locking pin on fulcrum pin (contact Woreda for help)
Worn bearings	Replace bearings

3.6.4.7 Keep Tools and Parts

One of your other jobs is to keep and look after the tools. You should keep them in a safe place so that they are available when they are needed for maintenance or repair. If you lose or damage them, then the community will have to replace them.

You will also be asked to buy and store spare parts. Let the WASHCO know when you will need more spare parts, so that they can raise the money in time.

Table 3-12 below is a schedule of the spare parts you will need and how often you will need them. You will stock spare parts at least for one year spares.

For Afridev:

Figure 3-12: schedule of spare parts for Afridev handpump

Part	Months					
	6	12	18	24	30	36
U-seal	1	1	1	1	1	1
O-ring		1		1		1
Bobbin		1		1		1
Rod Centralizer		2		2		2
Bearing bush	2	2	2	2	2	2
Hanger Pin				1		
Fulcrum Pin				1		
Foot Valve				1		

3.6.4.8 Keep Records

You will need to keep records so that you know what you have done with your pump including parts that you have replaced and repairs that you have done.

Keeping records will make it easier for you to report to the WASHCO about the condition of the pump. It will also make it easier to let an outside contractor or technician know what has already been done to the pump.



A MAINTENANCE RECORD SHEET is included with this manual. Whenever you carry out a repair or replace a part you should record it on this sheet.

More sheets are available from the Woreda if you fill up the first sheet. If you cannot write, ask the WASHCO secretary to help you.

An example of this form and how to fill it in is shown below.

Table 3-4: Example of maintenance record keeping format

DATE	PROBLEM	REPAIR DATE	PARTS USED	REPAIR BY
8/08/13	Water did not come U-seal worn	9/08/13	U-seal	Tegenew
17/10/13	Handle Loose Bearing worn	17/10/13	Bearings	Tegenew
1/8/13	Water did not come Broken Joint	14/12/13	Pipe Socket	External Support & Tegenew

3.6.4.9 Use the Pump Properly

Teach everyone, including children, how to use the pump properly. This will prevent the pump from becoming damaged and will save your community lots of money on parts and repairs.

Call a community meeting and agree on the rules for how the pump should be used.

Box 8: Rules for proper utilization of schemes

The following is an example of some of the rules you should agree to:

- ☞ Operate the pump handle until a continuous water flow has been achieved (pump ratio approximately 40 full strokes per minute).
- ☞ When pumping, stand directly behind the pump
- ☞ Use full strokes, not short strokes
- ☞ Don't bang the handle
- ☞ Do not let children play on or around the pump
- ☞ Do not let animals near the pump. Fence around the pump to prevent animals getting near.
- ☞ Do not allow clothes washing at the pump. This should be done away from the pump.
- ☞ Do not allow people to wash themselves at the pump. This should be done somewhere else.
- ☞ If children are going to collect water, then put a block for them to stand on when pumping.
- ☞ If the pump is showing signs of a problem, stop using it until the problem is identified and solved.

These are just some of the rules you should discuss with water users community. Make sure everyone understands and agrees to the rules.

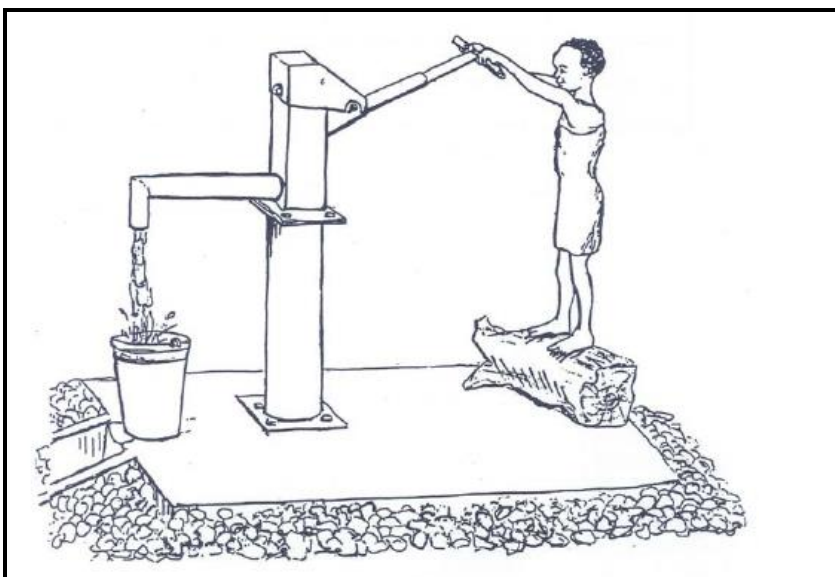

3.6.4.10 Everyone is a CARE-taker

The pump belongs to everyone in the community and so everyone is responsible for its care. If it breaks down, everyone suffers.

Everyone who uses the pump should help you care for it. They should do:

- ☞ Use the pump properly
- ☞ Inform the caretakers when they see a problem
- ☞ Help the caretakers solve the problem
- ☞ Help to clean and maintain the pump site

You can get the pump users – especially the women - to check the pump everyday when they collect water. Some things they can **LOOK** and **LISTEN** for include:

Everyone who uses the pump should help you care for it. They should do:

- ☞ REDUCED WATER FLOW
- ☞ DELAY IN WATER COMING FIRST THING IN THE MORNING
- ☞ LOOSE HANDLE
- ☞ PUMP DIFFICULT TO OPERATE
- ☞ LOOSE NUTS

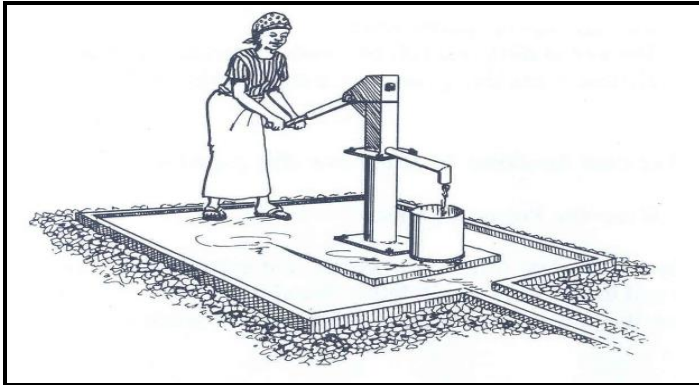

3.6.5 Indian Mark – II Hand Pump

The India Mark - II is suitable for a depth of up to 50 meters. The pump body parts are extremely durable over the years. The pump achieves high discharges in the range 25-45 meters. To service an Indian Mark II, higher skills and special tools are needed which require help from qualified mechanics at village.

3.6.5.1 Components of the Hand Pump & their Functions (India Mark II)

Below is a table explaining each component of the India Mark II pump. Please refer to the illustrations after the table for ease of understanding:

Table 3-5: Feature of an Indian Mark-II Hand Pump

Components	Features
Head Assembly	<ul style="list-style-type: none"> ▪ The mechanism above ground level and operating the plunger ▪ Sturdy mild steel box containing the handle pivot ▪ Heavy duty handle stop ▪ Simple inspection cover secured by a single bolt ▪ Flange mounts to water tank with third plate
Handle Assembly	<ul style="list-style-type: none"> ▪ Solid bar handle to counter-balance connecting rods ▪ Ball bearings ▪ Chain linkage for gravity return of the piston
Water Tank	<ul style="list-style-type: none"> ▪ Angled spout makes ingress of debris to water tank difficult ▪ Heavy duty riser pipe holder raised above the spout to prevent ingress of debris to cylinder ▪ Flange mounts to pedestal
Pedestal (Stand)	<ul style="list-style-type: none"> ▪ 150 mm B.B. pipe pedestal fits over borehole ▪ 125 mm B.B. casing pipe ▪ Angle iron legs to ensure firm bound to a concrete base ▪ Sanity seal created between OD of well casing and pedestal to prevent infiltration of polluted water to well
Connecting Rods	<ul style="list-style-type: none"> ▪ Provided linkage between pump head and cylinder ▪ Mild steel brighter bar, electro-galvanized for surface

Components	Features
	<ul style="list-style-type: none"> protection ▪ Threaded rods with hexagonal coupling and check nut ▪ 3 meter length for ease handling
Cylinder Assembly	<ul style="list-style-type: none"> ▪ Contains plunger, valves, etc lifting water upward in each stroke ▪ Cast iron case for low cost and to protect brass liner ▪ Brass liner with smooth finish to prolong Nitrile Rubber bucket washer life ▪ Nitrile Rubber seated valve poppet's for effecting sealing
Riser Pipes	<ul style="list-style-type: none"> ▪ Carries water from cylinder to the water tank ▪ 32 mm NB medium grade galvanized pipe in 3 meter lengths to facilities ▪ Installation and repair using hand tools

Figure 3-13: Cross-section of the upper part of Indian Mark-II

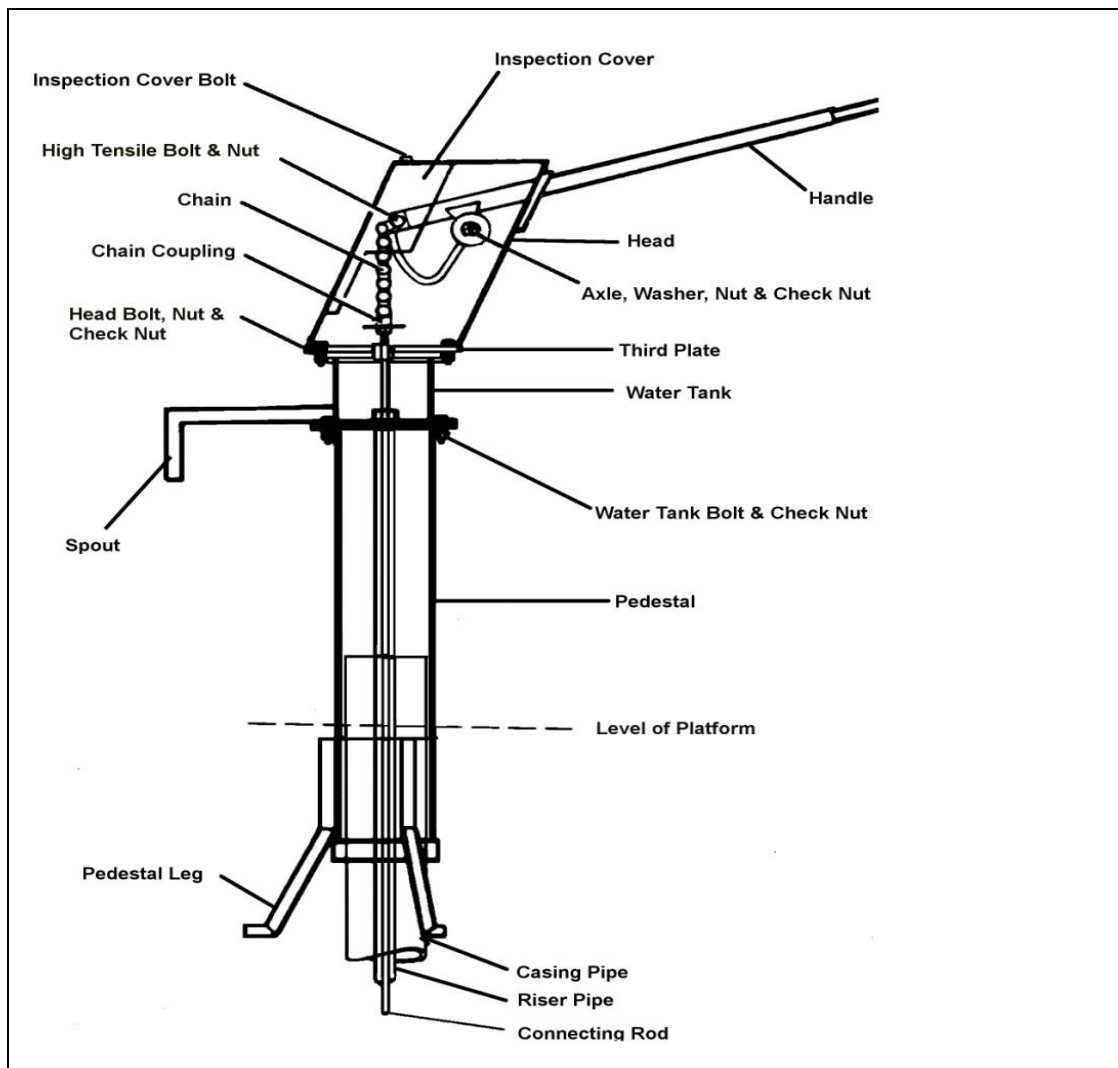
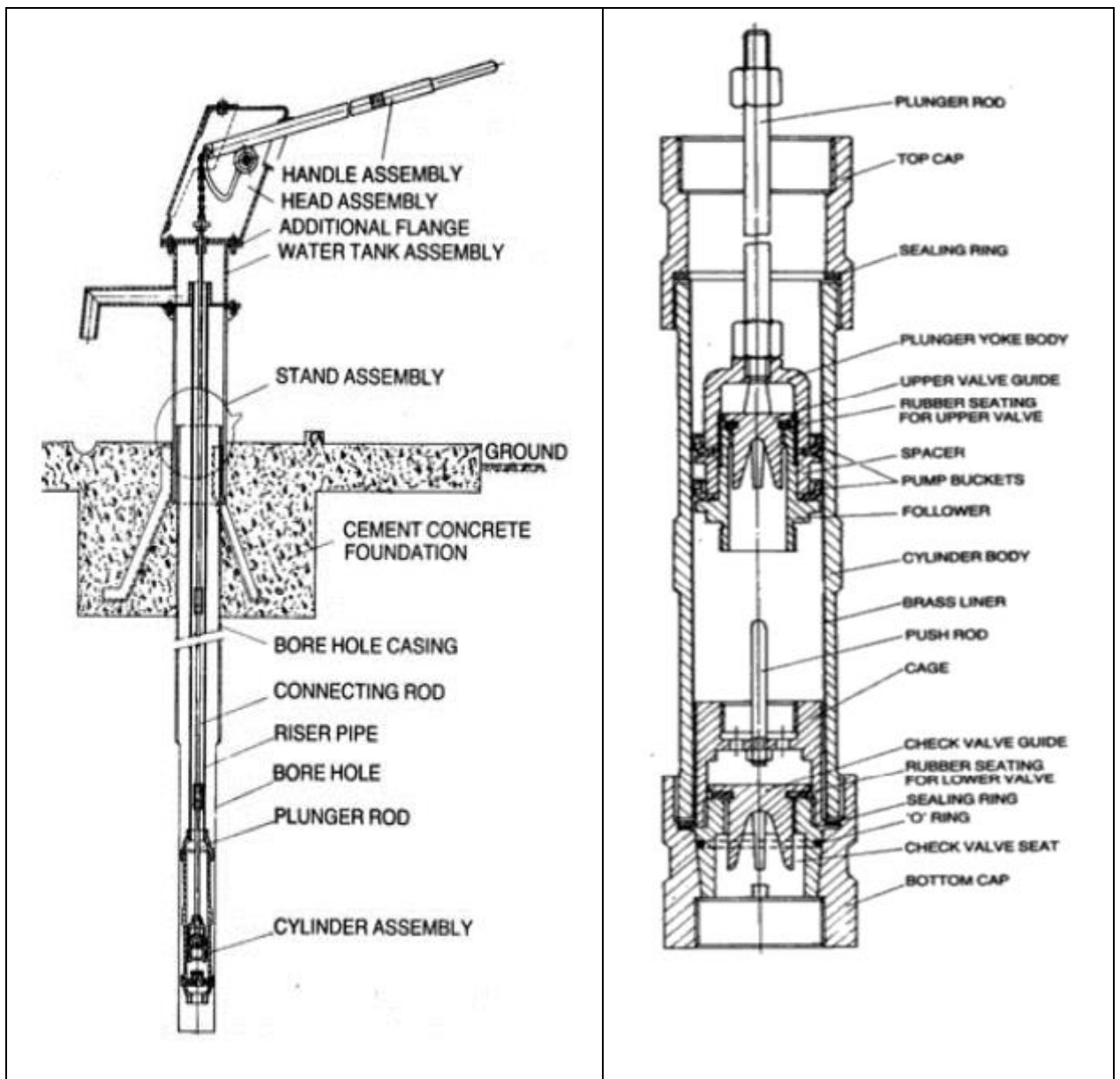

Figure 3-14: Details of Indian Mark -II Hand Pump



3.6.5.2 General Maintenance Schedule

The India Mark II hand pump is to be properly maintained to ensure safe potable drinking water. Maintenance will prevent breakdowns and ensure continuous working of the hand pump.

India Mark II hand pump is like any other mechanical machine. Any machine should be kept clean, if for no other reason than that in cleaning all parts are inspected for formation of rust, insufficient lubrication, loose, bolts, nuts, etc., and also for missing parts in time to prevent major failures.

As a Caretaker you should inspect the hand pump regularly, so you identify problems and solve them before they become too big. Regular checking will help to keep the pump in good working order and avoid big expenses for repairs Weekly, Monthly and Annual inspection activities should include the following O&M activities:

Box 9: Checklist for weekly inspection of Indian Mark-II hand pump

- 1. Weekly Inspections:**
- ☞ Check the fittings such as nuts, bolts and handle assembly and tighten them.
 - ☞ Check the axle bolt and tighten as needed.
 - ☞ Make sure the lock nut is tight.
 - ☞ Make sure the hand pump is firm on its base.
 - ☞ Check the flange bolts fastening the water chamber to the pedestal are tight.
 - ☞ • Testing water quality using a Field Test Kit.
 - ☞ problems reported to the WaSHCO's

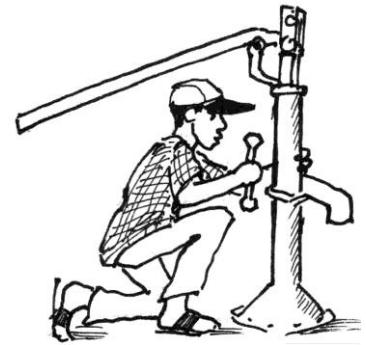

Figure 3-15: graphic demonstration of the weekly Inspection of the pump

<p>Check Fulcrum Nuts</p>	<p>Check Hanger Nuts</p>
<p>Check Fulcrum Pin Locker</p>	<p>Check Hanger Pin Locker</p>
<p>Check Flange Nuts</p>	<p>Check Base Nuts</p>

Box 10: Checklist for Monthly Inspection of Indian Mark-II hand pump**2. Monthly Inspections:**

- ☞ STROKE TEST – how many strokes of the pump handle until water comes?
- ☞ BUCKET TEST – how many strokes of the pump handle to fill a bucket?
- ☞ CHECK BEARINGS – are the bearings worn or broken?
- ☞ Tighten the handle axle nut and lock nut.
- ☞ Check for loose or missing flange bolts and nuts and tighten as needed.
- ☞ Open the cover and clean inside the pump.
- ☞ Check the chain anchor bolt for proper position and tighten if needed.
- ☞ Look for rusty patches, clean with a wire brush and apply anticorrosive paint.
- ☞ Find out whether the hand pump base is loose and arrange for repair of the foundation as needed.
- ☞ Measure the static water level.
- ☞ Greasing of all components.

STROKE TEST

Do this test early in the morning before anyone has used the pump. Count the number of full strokes before water comes. If the number of strokes increases from last month, or it takes longer than a few minutes for water to come, you should check the foot-valve.

Figure 3-16: Pictorial demonstration for stroke test for Indian Mark-II handpump

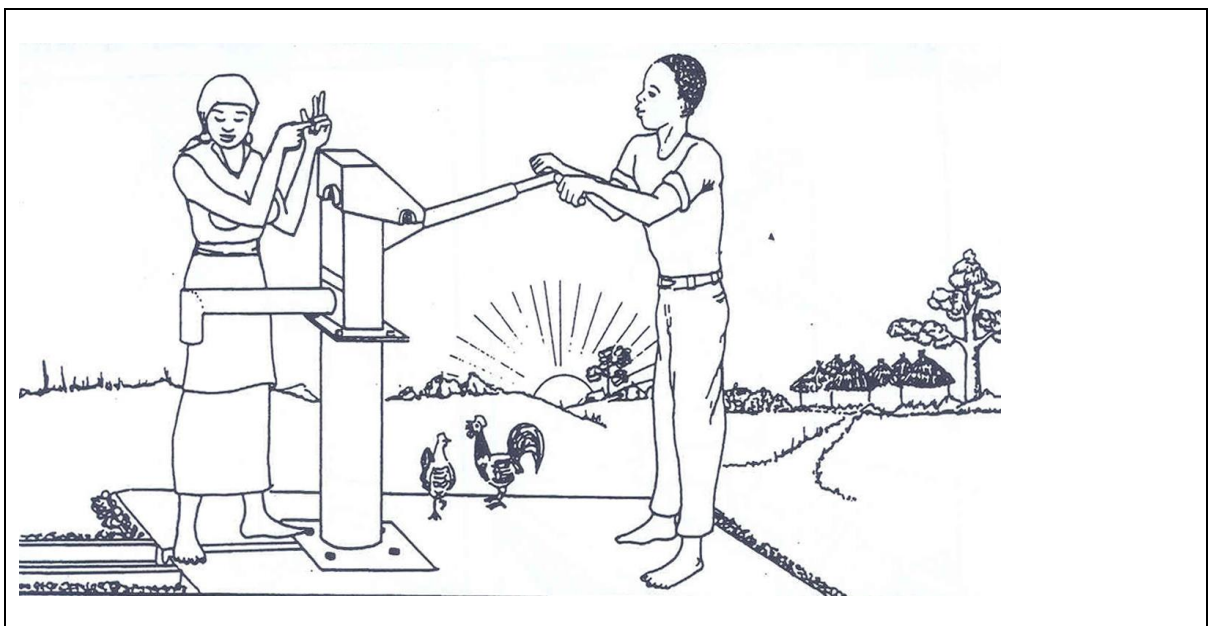

How many full strokes does it take for water to come first thing in the morning?

BUCKET TEST

Count the number of strokes to fill a bucket. You should always use the same size bucket for this test. If the number of strokes increases a lot, then change the U-seal.

Figure 3-17: Pictorial demonstration for bucket test for Indian Mark-II handpump

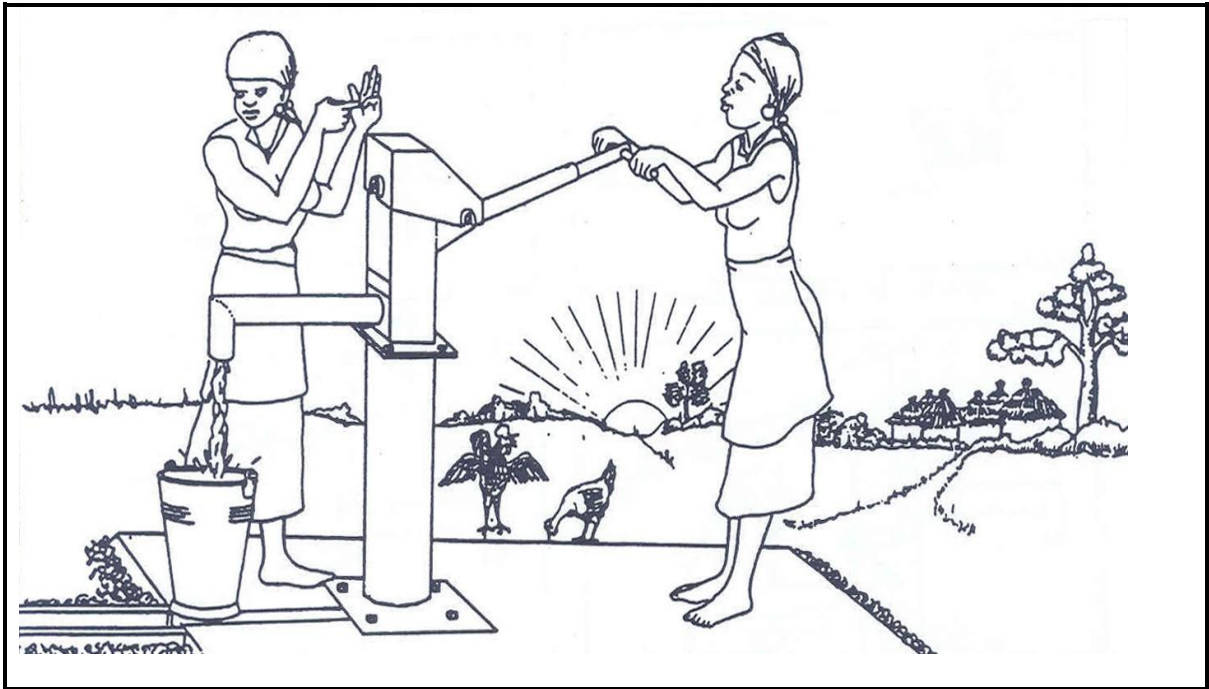

How many full strokes does it take to fill the same bucket with water?

CHECK BEARINGS

Remove the bearings to see if they are worn. Good bearings are smooth and turn easily. Worn bearings are scratched and loose. Replace worn bearings.

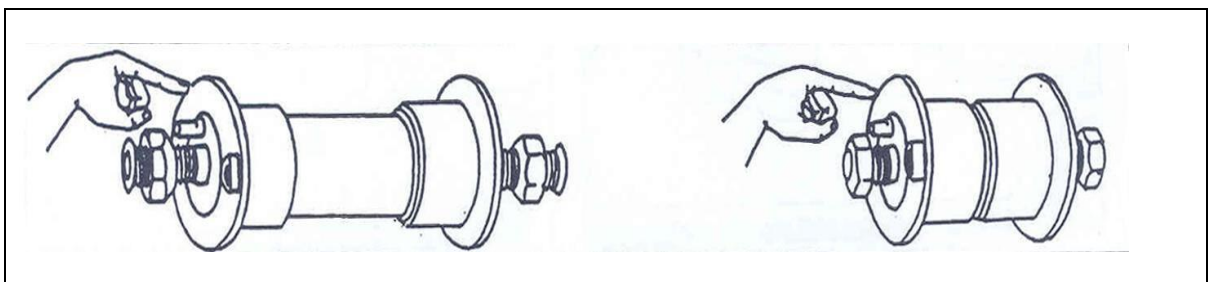

Are the bearings Spoiled?

Box 11: Checklist for Annual Inspection of Indian Mark-II hand pump**3. Annual Inspections:***a) Examine the hand pump carefully and check whether:-*

- ☞ Discharge is satisfactory
- ☞ Handle is shaky
- ☞ Guide bush is excessively worn out
- ☞ All bolts, nuts and washers are in position
- ☞ Chain has worn out
- ☞ - Roller chain guide is excessively worn out

b) Pull out the hand pump and follow the instruction given below:-

- ☞ If chain, bearing and spacer are damaged, replace them
- ☞ If roller chain guide is badly worn out replace handle assembly
- ☞ If any pipes are damaged replace them
- ☞ Open out cylinder assembly and replace cup washers, sealing rings and also any other part found defective
- ☞ Check the condition of water tank riser pipe holder. If threads are worn out, replace water chamber.
- ☞ Check all sub assemblies for crack in weld and other visual defects. If defects are serious replace sub assemblies
- ☞ Reinstall the hand pump as per instructions given in the manual. Paint the pump head inside/ outside with the recommended colour after cleaning/ sanding the surfaces.

3.6.5.3 Maintenance Procedure

The above maintenance schedule is applicable to the AFRIDEV pump as well and the following is the maintenance procedure:

- Remove the pump head.
- Loosen the hanger and the fulcrum nuts.
- Pass spanner handle through rod hanger eye.
- Slowly move the handle upwards and take it out.
- Remove the plastic bushes and hanger pin.
- Lift the spanner handle and hold the pump rods by hand then remove the spanner.
- Withdraw all connecting rods and plunger by disengaging eye and hook connectors.
- Connect fishing tool with pump rod.

- Lower the fishing tool into the rising main pipe by engaging connecting rods till it (fishing tool) touches the foot valve.
- Slowly rotate the pump rod till you get a feeling of the fishing tool hooking the pickup hook.
- Pull it with force to disengage foot valve from its position.
- Hold the pump rods till the water column drains.
- Take out all the pump rods one by one along with foot valve.
- Service the plunger & foot valve by replacing worn out rubber parts with new parts.
- Hold the foot valve from the hook and drop it in the riser pipe.

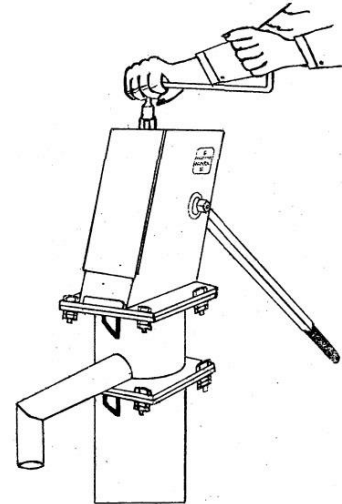

3.6.5.4 Routine Maintenance

You should do **ROUTINE MAINTENANCE** to identify and solve problems before they become big and expensive. This means tightening loose nuts, welding locker pins back on (if they have fallen off) and replacing worn out parts.

NUTS: Check that nuts are tight. However do not over tighten them – if you tighten too hard you may damage them.

STROKE TEST: If it takes a lot of pump strokes before water comes, check the foot valve. Replace the bobbin or O-ring if they are worn. Make sure the footvalve is properly seated.

BUCKET TEST: If it takes more strokes than usual to fill a bucket, remove the plunger and check the condition of the U-seal. Change the U-seal if it is damaged or worn

INDIA MARK II EXTRA DEEP: If the handle axle and chain have unusual sand/trembling, and stroke/bucket test is not usual, you may need to get help from the Woreda for these.

REMEMBER: If you solve a problem early, you will avoid a bigger problem later. This will save you and your community lots of time, effort and money in difficult and expensive repairs

3.6.5.5 SOLVE MINOR PROBLEMS

If there are problems with your pump, you should try to solve them quickly so that they don't become bigger problems. A delay may cause more damage to your pump and cost you more to repair and then the community cannot use the pump for a while.

Some problems you can solve yourself. Others you may need to get help from the Woreda (Water, Mining and Energy Office) to fix.

WATER DOES NOT FLOW AT ALL

Cause	Solution
Broken chain	Replace chain
Broken pump rods	Repair rods (contact Woreda for help)
Footvalve/plunger is not in place	Repair Cylinder (contact Woreda for help)
Low water yield	Contact Woreda for help

THERE IS DELAYED FLOW

Cause	Solution
Footvalve/plunger is not in place	Repair Cylinder (contact Woreda for help)
Broken or leaking pipe joint	Repair joint (contact Woreda for help)

THERE IS WEAK FLOW

Cause	Solution
Footvalve/plunger is not in place	Repair rods (contact Woreda for help)
Broken or leaking pipe joint	Repair rods (contact Woreda for help)
Low water yield	Contact Woreda for help

THE HANDLE IS LOOSE

Cause	Solution
Broken pump rods/chain	Repair rods/chain (contact Woreda for help)

3.6.5.6 GET HELP WITH MAJOR PROBLEMS

After three or four years, your pump will begin to have some major problems which you will need assistance to solve and repair. These problems will be too difficult for you to deal with on your own so you should contact the Woreda to get assistance with them.

If you can't solve or fix a problem yourself, report the problem to the WASHCO. The WASHCO will hire a Contractor or other technician to come and do the repair. He/she will be paid for his/her transport, his/her time and any materials and spare parts he/she uses.

You should be available to help him/her when he/she comes to do the repair. If you help



then you can make sure he/she does a proper job and also you can learn how the problem is solved so that you can do it yourself next time.

3.6.5.7 KEEP TOOLS AND PARTS

One of your other jobs is to keep and look after the tools. You should keep them in a safe place so that they are available when they are needed for maintenance or repair. If you lose or damage them, then the community will have to replace them.

You will also be asked to buy and store spare parts. Let the WASHCO know when you will need more spare parts, so that they can raise the money in time.

The table below is a schedule of the spare parts you will need and how often you will need them. You will stock spare parts at least for one year spares.

Table 3-6: Schedule of spare parts for Indian Mark-II handpump

Part	Months					
	6	12	18	24	30	36
Chain assembly		1		1		1
Ball bearing		1		1		1
Rubber seating		2		2		2
Cup seal		3		3		3
Sealing ring		3		3		3

3.6.5.8 KEEP RECORDS

You will need to keep records so that you know what you have done with your pump including parts that you have replaced and repairs that you have done.

Keeping records will make it easier for you to report to the WASHCO about the condition of the pump. It will also make it easier to let an outside contractor or technician know what has already been done to the pump.



A MAINTENANCE RECORD SHEET is included with this manual. Whenever you carry out a repair or replace a part you should record it on this sheet.

More sheets are available from the Woreda if you fill up the first sheet. If you cannot write, ask the WASHCO secretary to help you.

An example of this form and how to fill it in is shown below.

Table 3-7: Example of Maintenance record keeping format for Indian mark-II handpumps

DATE	PROBLEM	REPAIR DATE	PARTS USED	REPAIR BY
8/08/13	Water did not come. Chain broken	9/08/13	Chain	Tegenew
17/10/13	Handle Loose Bearing worn	17/10/13	Bearings	Tegenew
1/8/13	Water did not come Broken Rod	14/12/13	Pipe Socket	External Support & Tegenew

3.6.5.9 Use the Pump Properly

Teach everyone, including children, how to use the pump properly. This will prevent the pump from becoming damaged and will save your community lots of money on parts and repairs.

Call a community meeting and agree on the rules for how the pump should be used.

The following is an example of some of the rules you should agree to:

- ☞ Operate the pump handle until a continuous water flow has been achieved (pump ratio approximately 40 full strokes per minute).
- ☞ When pumping, stand directly behind the pump
- ☞ Use full strokes, not short strokes
- ☞ Don't bang the handle
- ☞ Do not let children play on or around the pump
- ☞ Do not let animals near the pump. Fence around the pump to prevent animals getting near.
- ☞ Do not allow clothes washing at the pump. This should be done away from the pump.
- ☞ Do not allow people to wash themselves at the pump. This should be done somewhere else.
- ☞ If children are going to collect water, then put a block for them to stand on when pumping.
- ☞ If the pump is showing signs of a problem, stop using it until the problem is identified and solved.

These are just some of the rules you should discuss with water users community. Make sure everyone understands and agrees to the rules.

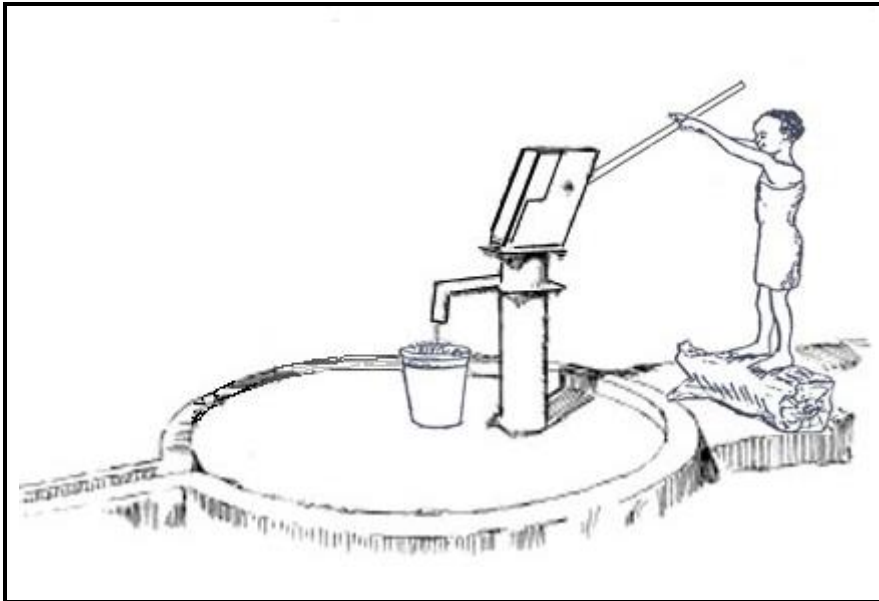

3.6.5.10 Everyone is a CARE-taker

The pump belongs to everyone in the community and so everyone is responsible for its care. If it breaks down, everyone suffers.

Everyone who uses the pump should help you care for it. They should do:

- ☞ Use the pump properly
- ☞ Inform the caretakers when they see a problem
- ☞ Help the caretakers solve the problem
- ☞ Help to clean and maintain the pump site

You can get the pump users – especially the women - to check the pump everyday when they collect water. Some things they can **LOOK** and **LISTEN** for include:

Everyone who uses the pump should help you care for it. They should do:

- ☞ REDUCED WATER FLOW
- ☞ DELAY IN WATER COMING FIRST THING IN THE MORNING
- ☞ LOOSE HANDLE
- ☞ PUMP DIFFICULT TO OPERATE
- ☞ LOOSE NUTS

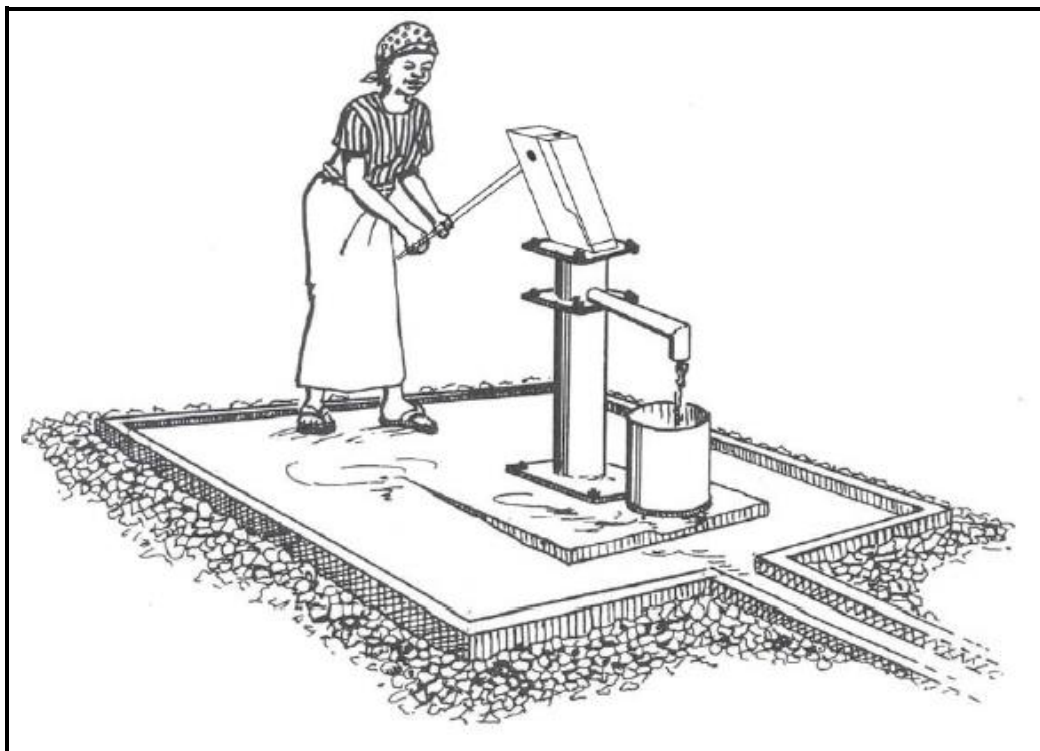

3.6.6 Troubleshooting – Causes and Remedies

a) Afridev Hand Pump

Below is a table illustrating the common causes and their respective remedies for the Afrideve handpump.

Table 3-8: Trouble shooting for Afrideve

Trouble		Cause	Remedy
No Water	Handle operation is easy	<ul style="list-style-type: none"> Pump rods are disconnected 	<ul style="list-style-type: none"> Pull out all pump rods and replace broken and corroded rods
	Handle operation is difficult	<ul style="list-style-type: none"> Riser pipe disconnected, 	<ul style="list-style-type: none"> Pull out complete rising main repair/replace pipes (solvent cement) joints
	Handle operation is normal	<ul style="list-style-type: none"> U-seal or cup seal is defect Borehole is clogged (split or sand), Water level dropped below cylinder 	<ul style="list-style-type: none"> Replace seal, Rehabilitation of borehole (cleaning with compressed air or by bailing) Add riser pipes Bobbins (plunger and Foot valve)
Delayed water flow	Handle operation is normal	<ul style="list-style-type: none"> Leaking of valve Bobbins, Leaking of Foot valve O-ring Leaking in pipe joint or rising main pipe is perforated, 	<ul style="list-style-type: none"> Check and replace Bobbins (Plunger and Foot valve), Replace O-ring, Pull out complete rising main, repair/replace pipes (solvent cement joints),
Reduced Discharge	Handle Operation is difficult	<ul style="list-style-type: none"> U-seal or Cup seal is too tight 	<ul style="list-style-type: none"> Replace with seal correct size
	Handle operation is normal	<ul style="list-style-type: none"> Full stroke is not possible U-seal or Cup seal is worn Leaking or valve Bobbins Leaking of the cylinder (cracked) 	<ul style="list-style-type: none"> Check and adjust length of the top rod Replace seal Check and replace Bobbins (plunger and Foot valves) Pull complete rising main, repair/replace cylinder (solvent cement joints)
Abnormal Operating Noise	Handle operation is normal	<ul style="list-style-type: none"> Pump rods rubbing on riser pipes Pump rod centralizer worn 	<ul style="list-style-type: none"> Check and replace worn pump rod centralizers Check and straighten bent pump rods, replace worn pump rod centralizers
	Handle operation is inconvenient	<ul style="list-style-type: none"> Pump rods are toughing riser pipes Bearing are worn, handle fork touching the sides of pump 	<ul style="list-style-type: none"> Straighten or replace ben pump rods, replace worn pump rod centralizers Check and replace bearing

Trouble		Cause	Remedy
		head	sets (4 off)
Pump handle Shaky	Handle is shaky when operated	<ul style="list-style-type: none"> ▪ Bearing are worn ▪ Fulcrum pin is loose <p>Hanger pin is loose</p>	<ul style="list-style-type: none"> ▪ Check and replace bearing sets (4 off) ▪ Check Fulcrum pin (and Bearing sets tighten both nuts fully) ▪ Check hanger pin (and bearing sets) tighten both nuts fully
	Pump head shaky	<ul style="list-style-type: none"> ▪ Flanges are loose 	<ul style="list-style-type: none"> ▪ Tighten all bolts and nuts of the flanges
	Pump stand is shaking	<ul style="list-style-type: none"> ▪ Pump platform is cracked 	<ul style="list-style-type: none"> ▪ Repair pump platform or well cover (for dug wells)

b) Indian Mark-II Hand Pump

Below is a table illustrating the common causes and their respective remedies for the India Mark II

Table 3-9: Trouble shooting for India Mark II

Trouble	Cause	Remedy
Pump hand works easily but no flow of water	<ul style="list-style-type: none"> ▪ Water level gone down below the cylinder assembly, ▪ Worn out cylinder leather cup washer, ▪ Connection rod joint disconnected ▪ Valve seats worn out, ▪ Pump cylinder cracked 	<ul style="list-style-type: none"> ▪ Add more pipes and roads, ▪ Overhaul the cylinder and replace the leather cup washer, ▪ Pull out the pump and join the connecting rod where necessary, ▪ Replace valve seats
Delayed flow or small flow	<ul style="list-style-type: none"> ▪ Damaged/leaking rising main, ▪ Leaking in cylinder check valve or upper valve, ▪ Rubber cup washers worn out. 	<ul style="list-style-type: none"> ▪ Replace the damaged/leaking pipe or disconnect the affected rising main, ▪ Overhaul cylinder. Replace worn out rubber seats or bend check valve seats.
Folding of chain during return stroke	<ul style="list-style-type: none"> ▪ Improper erection. Top rod above water tank flange level (Top flange) ▪ Rubber cup washers getting jammed inside the cylinder, 	<ul style="list-style-type: none"> ▪ Adjust the length of top connecting rod suitably, ▪ Overhaul the cylinder and replace rubber cup washers if damaged or replace the cylinder body if deformed.
Noise during operation	<ul style="list-style-type: none"> ▪ Stand assembly flange not leveled properly, ▪ Bearing worn out ▪ Bent connecting rod, 	<ul style="list-style-type: none"> ▪ Level the flange using spirit level, ▪ Replace ball bearing, ▪ Straighten the rod,

Trouble	Cause	Remedy
	<ul style="list-style-type: none"> Hexagonal coupler welder offset 	<ul style="list-style-type: none"> Replace spacer
Shaky Handle	<ul style="list-style-type: none"> Loose handle axle nuts, Worn out ball bearing, Spacer damaged or short in length, Bearing loose in the bearing housing 	<ul style="list-style-type: none"> Tighten handle axle nuts, Replace ball bearings, Replace spacer, Replace the handle assembly

3.6.7 Rope Pump

The Rope pump is a lift pump with continuous upward movement of a rope and a number of pistons in a tube. The Rope pump has a relative lightweight construction and is made of locally available materials and can be produced and repaired locally.

The basic parts of a rope pump are a pulley wheel above the well, a riser pipe from under the water level to an outlet just under the wheel, and a rope with rubber or plastic washers. The rope comes up through the pipe, over the wheel; back down into the well and into the bottom of the pipe, completing the loop. When the wheel is turned, the washers move upwards and lift water into the pipe towards the outflow. Other important parts are an underwater rope guide that directs the rope and washers back into the pipe, and a frame that holds the pulley wheel. The rope pump can be made at village level using wood, rope and PVC tubing (or bamboo canes with the centers bored out).

Water can be lifted from as deep as 50 m and raised to 5 m above ground level. Special models with 3-inch boreholes, and powered by windmills, bicycles, animal traction, electric motors or small gasoline engines, give good results.

Figure 3-18: Typical Rope Pump

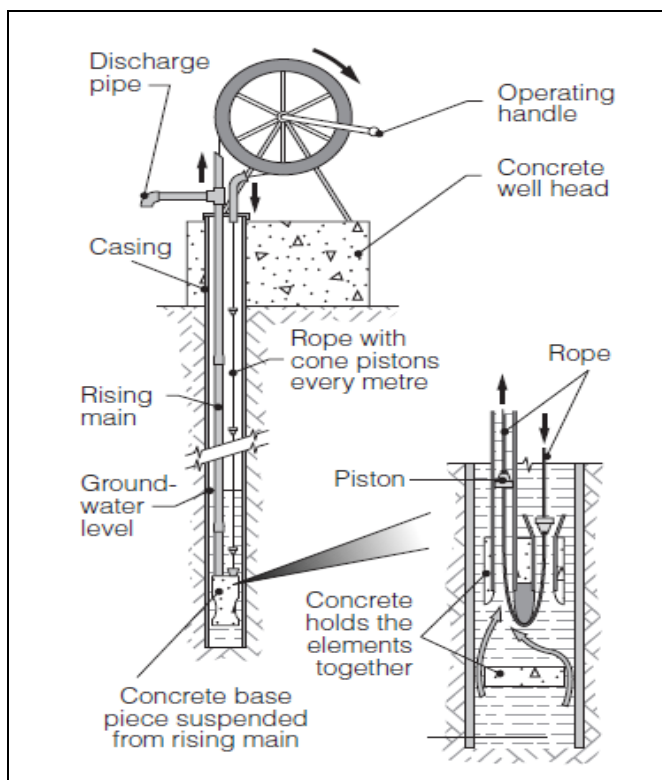

3.6.7.1 The advantage and disadvantage of the Rope pump

Advantages	Disadvantages
<ul style="list-style-type: none"> ▪ Low cost, a cheap pump on household level (<10 households). • Absence of dynamic forces (rotating movement). • Tubes can be made of low pressure PVC tubing. • The total weight of pump parts is approximately 15 Kg (which is 5 to 10 times less than piston pumps). The pump can be taken from the well without any lifting tool. • No valves, valve seats, and ball bearings. Therefore less 'critical' parts, resulting in higher reliability. • High overall efficiency 80 – 85% (if well made). • Technology, without 'black box', is easy to understand, produce and maintain. 	<ul style="list-style-type: none"> ▪ The Rope pump is not 100% closed. At the discharge and return tube, the pump is open to the air and contamination of the rope is possible via contact by hand. ▪ The Rope pump is not a pressure pump (no pressure in outlet). ▪ Especially with deep wells, it takes some time before the Rope pump delivers water. (When not in use, the water level in the pump falls back to the water level in the well). ▪ The Rope pump is NOT designed for communal use by more than 10 households. ▪ "Stone age" image. Many people know the Rope pump as a self made, low lift pump. This image hampers acceptance by water organizations, institutes and users.

3.6.7.2 Various Rope pump models

a) The manually operated pump models

The manually operated Rope pump models can be divided in options for boreholes (tube wells) and hand dug wells. The choice for the model to be used depends on the well type and the budget of the owner.

The following three models are available:

- The **AB Model** is designed for boreholes (tube-wells).
- The **AH model** is designed for hand dug wells and preferably includes a concrete well cover.
- The **Pi Model** is sometimes used on hand dug wells on household level.

Figure 3-19: AB and AH Model Rope Pump

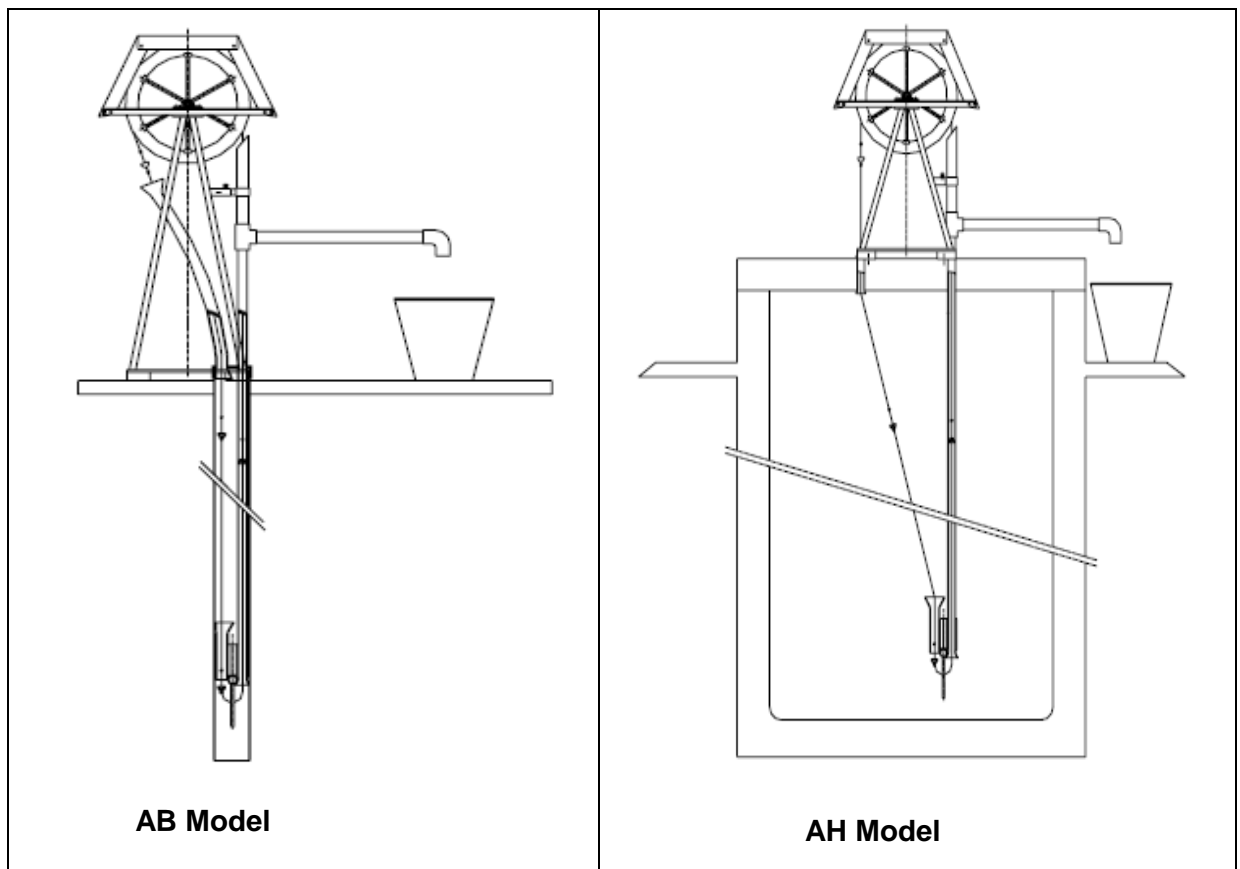

3.6.7.3 General data of the Rope pump

No.	Parameters	Description
1	Discharge ¹	Water level: up to 10 m depth: 35 liter/min up to 20 m depth: 20 liter/min up to 35 m depth: 10 liter/min
2	Maximum depth	35 meter (water level)
3	Input power ¹	approx. 50 Watt
4	Discharge level	1 m above ground level (no pressure) (with an additional wheel and structure up to 6 m above ground level)
5	Application	1 – 10 households (approximately 75users maximum)
6	Cost	€ 60 - € 120 (depending on model and country)

Note 1): The discharge is based on an input power of approx. 50 Watt, which is the power that women and children can deliver for longer periods.

3.6.7.4 Operation of Rope Pump

Functioning and life time of the pump will be increased when care is taken during operation of the pump.

Guidelines:

- ☞ Only rotate the pump clockwise, never turn the pump reverse direction.
- ☞ Always use the pumping lock when pumping is stopped.
- ☞ Don't let very small children operate the pump. If the handle slips out of their fingers, the pump will turn in backwards direction and the handle could hurt the children.
- ☞ Don't operate the pump with more than one person at the time. Avoid children hanging on the handle.

3.6.7.5 Regular maintenance

Regular maintenance is necessary to keep the pump in good shape and guarantee a long running time.

Regular Tasks:





- ☞ Checking the tension of the rope and adjusting when needed.
- ☞ Lubricating the bushings every 2 weeks or when the bushings are running dry
- ☞ If the bushings start to make a shrieking noise oiling is URGENTLY needed. Add a few drops of NEW motor oil. (In case motor oil is not available, cooking oil can be used for emergency).
- ☞ Carry out repairs when needed.





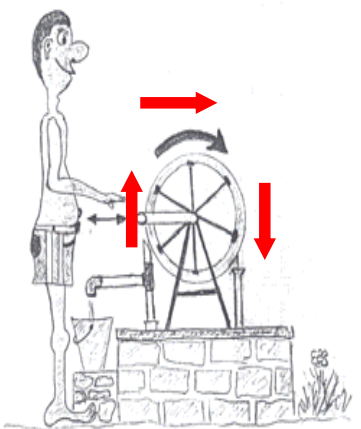

3.6.7.6 Other Maintenance Requirements

Table 3-10: others rope pump maintenance requirements

Potential repairs	Descriptions
Replacement of the rope	<ul style="list-style-type: none"> ▪ Pistons usually last about twice as long as the rope. When the rope shows a lot of damage, the rope should be changed preferably before it breaks. ▪ Tie the new rope (with the pistons) to the old rope (be sure pistons are running in the right direction) and pass it through the tubing. It is not necessary to take out the tubing.
Replacement of pistons	<ul style="list-style-type: none"> ▪ The pistons should be changed, when the user has noted a reduction output. ▪ Before changing the pistons, check the clearance in a piece of riser main to check whether a reduced output is due to worn-out pistons
The bushings	<ul style="list-style-type: none"> ▪ If bushings are worn out, dismantle and replace them. (If properly oiled, bushes last for 10 years or more!)
PVC tubing	<ul style="list-style-type: none"> ▪ If a pump is placed in direct sunlight, the ultra-violet rays will affect the PVC parts, causing cracks. (To prolong life of PVC, paint it!) ▪ If the well contains fine sand, the sand will wear out PVC parts as well. In case wear is excessive, replace tubing.

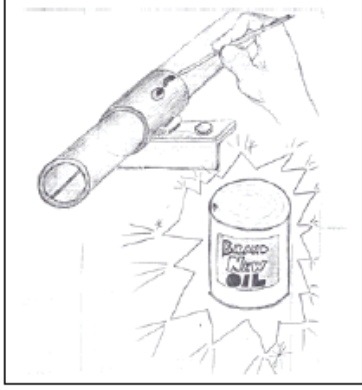
3.6.7.7 Operation- and Maintenance sheet

 <p>Pump Direction</p>		 <p>Do not go on the Handle</p>
 <p>pump lock closed if not in use</p>	 <p>pump lock open during operation</p>	

 <p>Lubricate the bushing</p>		
 <p>Check rope play</p>	 <p>Making a loop</p>	 <p>The loop/ seam end of the loop</p>

3.6.7.8 Description of O&M Activities for Rope Pump HDW

The daily, Monthly and Annual activities should include the following O&M activities:

Box 12: Daily Activities for rope pump HDW

1. Daily Activities:

- ☞ Check for any debris in the well by regular visual inspection
- ☞ Clean the concrete apron
- ☞ Clear the drains
- ☞ Check that the gate is closed
- ☞ Check the condition of the rope, pulley, bucket and fence by regular visual inspection

Box 13: Monthly Activities for rope pump HDW**2. Monthly Activities:**

- ☞ Replace the bucket and other parts as needed
- ☞ Check the concrete apron and well seal for cracks and repair them with cement mortar
- ☞ Record the water level with a rope-scale and report to the WaSHCOs
- ☞ Lubricate the components with grease periodically.
- ☞ De-silting of dug wells periodically as required

Box 14: Annual Activities for rope pump HDW**3. Annual Activities:**

- ☞ Dewater the well and clean the bottom
- ☞ Inspect the well walls and lining and repair as needed
- ☞ Check the water level and deepen the well as needed
- ☞ Check the support posts for the pulley and repair as needed
- ☞ Record the depth of water level & depth of well with a rope scale and report the WaSHCOs

3.6.8 O&M Resources for Had Dug Well

Unskilled labor is required for daily tasks and for collecting user charges. Semi-skilled labor (well caretaker) is needed to carry out weekly and monthly O&M tasks; a private fitter may be needed to repair the well pulley. Skilled labor (mason) is needed to work with the caretaker on yearly O&M tasks and to repair the concrete apron and support posts for the pulley.

Materials and equipment include the bucket and rope, fencing, support posts, brush, digging and hand tools, cement, pulley and pulley shaft and bearings, and masonry tools to be provided to the caretakers.

3.7 Spring Collection Chambers

3.7.1 Description of O&M requirement for On-Sport Spring

The main parts of a spring protection are a drain under the lowest natural water level, a protective structure providing stability and a seal to protect surface water leakage. The drain usually is placed in a gravel packed and covered with sand & may lead to a conduit or a reservoir.

The protective structure may be made of paddled clay and sometimes plastic. A screened overflow pipe guarantees that excess water can flow freely out of the spring at all times. To prevent contamination from surface water infiltrating, a ditch, known as the interceptor drain, diverts surface water away from the spring box and a fence keeps animals out of the spring area.

There are many types of spring protections, ranging from a simple head wall with backfill to more complicated structures like tunnel systems for collecting water from large areas.

3.7.2 Maintenance Schedule

Box -15 below indicates the lists of caretaker tasks for spring water sources development.

Box 15: Caretakers task for the spring water sources

CARETAKER TASKS for community spring source schemes

1. **ORGANISE THE WORK.** Talk to and work with the other caretaker(s) so that you help each other and share the work load.
2. **WORK WITH THE WUC/WaSHCO,** so that your work and theirs help keep the water flowing for the community
3. **INSPECT THE SPRING BOX, RESERVOIR AND TAP STAND AND SITE** Every Month
4. **DO ROUTINE MAINTENANCE** – check for leaks, check washers in taps, pipe joints etc
5. **IDENTIFY AND SOLVE MINOR PROBLEMS**
6. **GET HELP FROM THE WOREDA TO SOLVE MAJOR PROBLEMS**
7. **KEEP YOUR TOOLS IN GOOD CONDITION, AND BUY & STORE SPARE PARTS**
8. **KEEP RECORDS** – of parts and repairs
9. **MAKE SURE THE DEVELOPED SPRING IS USED PROPERLY**
10. **ORGANISE THE COMMUNITY FOR GENERAL SITE MAINTENANCE**

3.7.2.1 Organise Your Work

The benefiting community has to select at least two caretakers to do the job of maintaining and caring for the developed spring water source.

You should consult with other scheme caretaker and decide how you are going to work together. You should decide which of you will do each task. For example, one caretaker can look after the tools and spare parts and the other caretaker can look after the records

On some tasks you should work together. For example, you should inspect the spring box and tap stands together on a monthly basis, and carry out repairs together. This way you can help each other.

If one of you has to enter the spring box or reservoir to check the condition, the other should stay outside and make sure everything is ok



3.7.2.2 Work with the WUC/WaSHCO

As scheme Caretaker, YOU ARE NOT ALONE. You don't need to do everything yourself. You are a member of the WUC/WaSHCO and you can get other members to help you.

You should attend WUC/WaSHCO meetings and let the other members know what you are doing. If they know what you are doing, they will support you when you need help.

Box 16: Caretaker report contents to WASHCO

At every WUC/WaSHCOM meeting you should give a report on:

- The **SPRING BOX:** Is it in good condition? What have you found when you have inspected it? Are there leaks or cracks? Does water flow out of the overflow pipe? Is the manhole cover in good condition?
- The **TAP STAND:** Are any of the taps leaking? How is the drainage around the tap stand? Is there any stagnant water? Do you need any spare parts for taps or other parts of the system?
- **REPAIRS:** Are there any repairs that need to be carried out?
Can you do them yourself or do you need help from the Woreda?
- **SITE CONDITION:** How is the fencing and drainage around the spring? Is there need for some general site maintenance (clearing vegetation, cleaning drainage etc)? Can you get help from other community members to do this?

Let the other WUC/WaSHCO members know how they can help you. For example they could buy the spare parts that are needed, arrange for other community members to clean the site or help you repair the spring box, taps or reservoir.



3.7.2.3 Inspect the Spring Box, Reservoir, Tap Stand and Site

Every month you should do a general inspection of the whole system. This includes:

Box 17: Lists of Spring Box, Reservoir and Public Water point Inspection

A. The Spring Box

- Check the general condition. Are there cracks in the concrete or signs of leaks?
- Is there wet ground around the spring box? This may indicate a leak.
- Is water flowing out of the overflow pipe? If so this may indicate a blocked outlet pipe.
- Is there stagnant water around the spring box? If so proper drainage must be provided,
- Is the spring box having algae? If so clean and disinfect the spring box
- Is the spring box properly protected from external pollutants? If so properly protect the spring box.
- Open the manhole cover and look inside. Does it look clean and in good condition? Is there anything in there such as leaves, sticks or other vegetation?

B. The Reservoir

- Check the general condition. Are there cracks in the concrete or signs of leaks?
- Is there wet or boggy ground around the reservoir? This may indicate a leak.
- First thing in the morning before people have started collecting water, and with all the taps off, is there water flowing out of the overflow? Check how full the reservoir is. How does it compare with when the spring was first constructed? If there is less water, there may be a blockage or leak in the spring box or connecting pipe.
- How is the drainage from the overflow pipe?.
- Open the manhole cover and look inside. Does it look clean and in good condition? Is there anything in there such as leaves, sticks or other vegetation?

C. The Tap Stand / Public Fountain

- Check all the taps. Are any of them leaking or broken? Do they all work properly (do they turn on and off)?
- What is the condition of the apron and drainage? Is there any water ponded or boggy ground? Does spilt water flow away to a soakage area?
- Check the condition of the concrete. Are there any cracks or signs of deterioration?

D. The Site

- Check the condition of the fence. Walk all around the fence and make sure that it is in good condition and there are no holes or places where animals can get in.
- Check the surface water diversion ditch. Is it clear? Is there any water sitting in it?
- What is the general condition of the site? Does it need to be cleaned of excess vegetation or other materials?
- Walk along the pipelines connecting the spring box to the reservoir and the reservoir to the tap stand (and any other pipelines if they exist – for example to clothes washing area or an animal watering trough). Are there any wet patches? These may indicate leaking pipes or pipe joints. Check any gate valves to make sure they are in good condition and are not leaking.

Table 3-11: Summary of O&M Requirement for Spring Protection

Activity	How Often	Who by	Materials & Spare Parts	Tools & Equipment
Clean Spring surroundings	Weekly	Community		Broom, bucket, hoe, machete
Repair fence and clean surface drains	Monthly	Caretakers & Community (as necessary)	Wood, rope, wire	Machete, axe, knife, hoe, spade, pickaxe
Repair pipes and taps	As needed	Caretakers & Contractor (as necessary)	Spare pipes, valves, joints, taps, washers, cement, sand, gravel	Bucket, trowel, spanner (wrench), flat spanners
Check water quantity	Monthly	Caretakers		Bucket, watch
Check water turbidity	After each heavy rain or flood	Caretakers		
Check water quality	Annually or after repair	Contractor &/or Woreda	Laboratory supplies	Laboratory
Wash and disinfect spring	Annually or after repair	Contractor &/or Woreda	Chlorine	Bucket, wrench, brush
Repair faucets	When the need arises	Caretakers	Spare faucet and thread.	Wrench
Repair cracks	When the need arises	Caretakers	Cement, sand gravel	Bucket, trowel, hoe, spade, wheel barrow

Figure 3-20: Typical Feature of On-Spot Spring Box

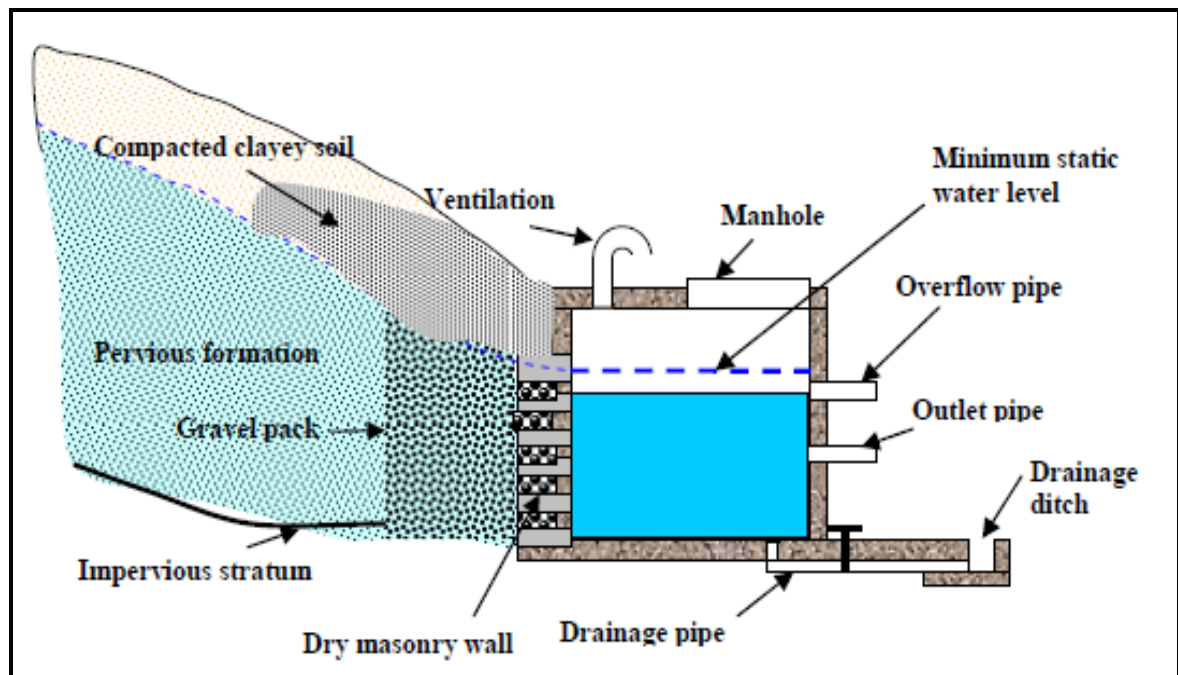

Figure 3-21: Typical Plan of Spring Development with Spring Box

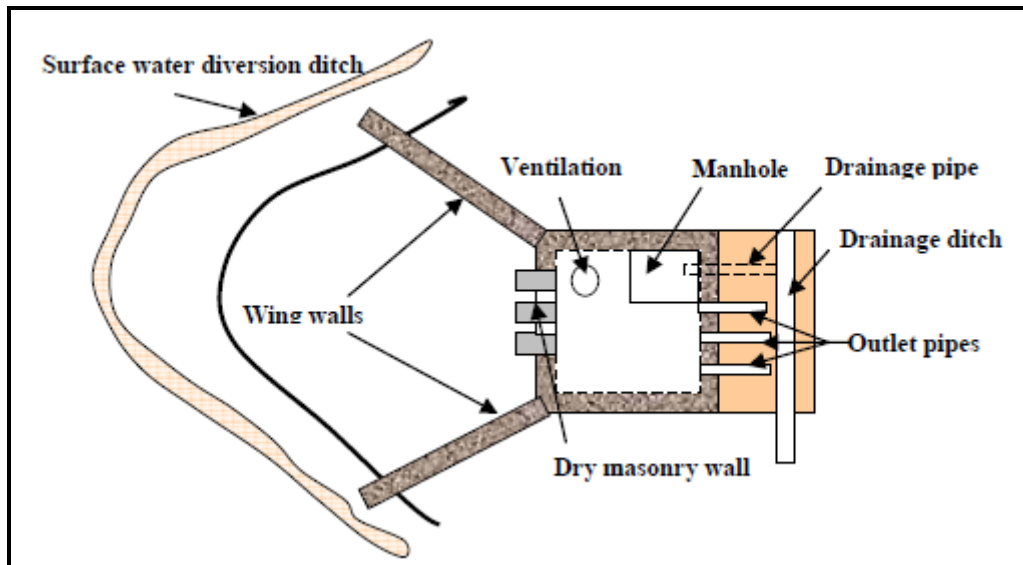

Table 3-12: O&M of Spring Box

Part	Function	Operation	Maintenance
1 Over Flow	To keep the maximum pressure balanced, in order to protect the spring protection	Over flow will withdraw automatically	No maintenance required
2 Valve Box	To protect the Outlet Valve	Open and Close by steel cover with padlock	Always keep it locked. <u>Keep Children away</u> Clean the sediment
3 Outlet Valve	Controls the water flow which goes in to collection chamber/users	Always stay open, should be closed only when collection chamber is going to be cleaned up	Don't force the valve to be opened to the maximum or closed tight
4 Washout End Cap	To extract the sediment from the spring protection	It should be opened at least once a month to clean spring protection	When tighten the cap, clean up the screw by water
5 Strainer	It filter the water which goes into the collection chamber/users from sand and other external substance	Strainer operates automatically	Wash the silt on the strainer by water, when it's needed
6 Manhole	An entrance, to check and clean the spring protection when it's needed	Open the lock to enter in the spring protection to clean and maintain	Always keep it locked. Keep children away from it.

3.7.2.4 Routine Maintenance

You should do **ROUTINE MAINTENANCE** to identify and solve problems before they become big and expensive. This means replacing tap washers, repairing broken taps and pipe joints and fixing any leaks in the spring box or reservoir.

a) How to Change a Tap Washer

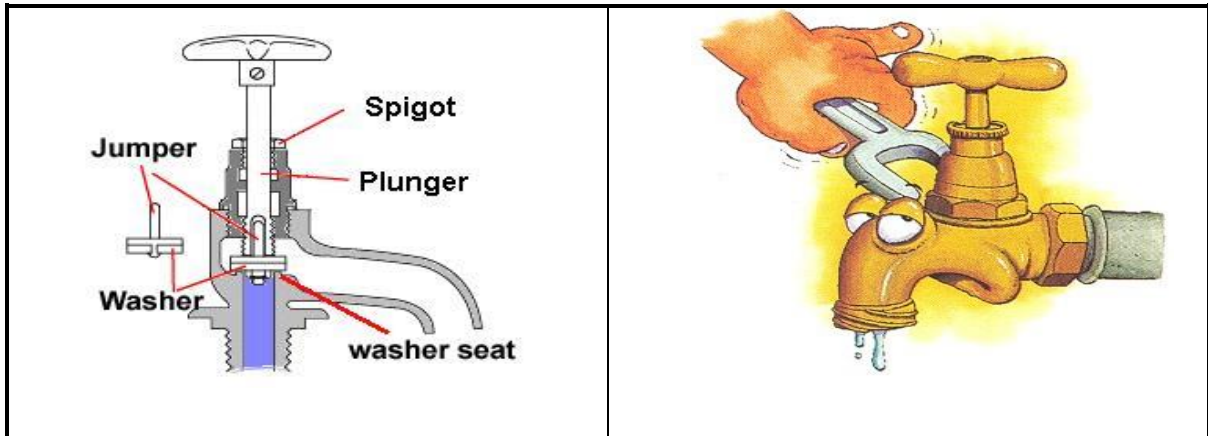

Box 18: Procedures for Routine Maintenance of Spring Box

- Turn off the water supply from the reservoir using the gate valve
- Open the tap to release any water pressure and release the force on the tap plunger and spigot
- Using a spanner, undo the tap spigot and remove the plunger and spigot assembly, with the washer
- Replace the washer with a new one
- Replace the plunger and spigot. Tighten gently with the spanner. **DO NOT OVERTIGHTEN**
- Open the gate valve at the reservoir to turn on the water flow
- Check the tap for leaks. If the tap still leaks, then the whole tap may need to be replaced.

REMEMBER: *If you solve a problem early, you will avoid a bigger problem later. This will save you and your community lots of time, effort and money in difficult and expensive repairs.*

3.7.2.5 Solve Minor Problems

If there are problems with your spring development, you should try to solve them quickly so that they don't become bigger problems. A delay may cause more damage; cost you more to repair and mean the community cannot use the scheme for a while.

Some problems you can solve yourself. Others you may need to get help from the Woreda to fix.

Some common problems you may have included:

Table 3-13: Solving Minor Problems for Spring Box

Problem	Cause/Solution:
Leaking Taps	Repair taps
Boggy Ground	Look for leaks in spring box, reservoir etc
Low flow at taps	Blocked pipes – clear pipes Clogged spring box – clean out Empty Reservoir – check flow from spring box
Poor drainage	Drains clogged with vegetation – clean out
Dirty/smelly water	Fence broken – repair Drainage inadequate – clean drains NOTE: If the water has become contaminated – the system must be flushed with chlorine. Contact the Woreda for assistance with this.

3.7.2.6 Get Help with Major Problems

Every few years you may begin to have some major problems which you will need help to solve and repair. These problems will be too difficult for you to deal with on your own so you should contact the Woreda Water Resource Office (WRO) to get assistance with them. If it is beyond the capacity of the WRO, the Zonal Water Resource Development Office (ZWRDO) shall be consulted.

If you can't solve or fix a problem yourself, report the problem to the WUC/WaSHCO. The WUC/WaSHCO will get external support to do the repair. Payment for external support could be done based on the mutual agreement made between the two parties.

You should participate on the repair work being done by the external support. If you help then you can make sure he/she does a proper job and also you can learn how the problem is solved so that you can do it yourself next time.

Examples of major problems include:

- Contaminated Water: Flushing the system with chlorine once the source of contamination has been identified and solved
- Major cracks/leaks in spring box or reservoir
- Major leaks in pipelines.



3.7.2.7 Keep Tools and Parts

One of your other jobs is to keep and look after the tools. You should keep them in a safe place so that they are available when they are needed for maintenance or repair. If you lose or damage them, then the community will have to replace them.

You will also be asked to buy and store spare parts. Let the WUC/WaSHCO know when you will need more spare parts, so that they can raise the money in time.



3.7.2.8 Keep Records

You will need to keep records so that you know what you have done with your spring development including parts that you have replaced and repairs that you have done.

Keeping records will make it easier for you to report to the WUC/WaSHCO about the condition of the spring development. It will also make it easier to let an outside contractor or technician know what has already been done.

A MAINTENANCE RECORD SHEET is included with this manual. Whenever you carry out a repair or replace a part you should record it on this sheet. More sheets are available from the Woreda if you fill up the first sheet.



If you cannot write, ask the WUC/WaSHCOM secretary to help you.

An example of this form and how to fill it in is shown below.

Table 3-14: Spring Chamber Maintenance Sheet

DATE	PROBLEM	REPAIR DATE	PARTS USED/REPAIR CARRIED OUT	REPAIR BY
8/08/13	Tap leaking	9/08/13	Tap washer	Biliso
17/10/13	Spring box clogged	17/10/13	Spring box cleared	Biliso
1/8/13	Leak in reservoir wall	14/12/13	Cement	External Support & Biliso

3.7.3 Proper Use of the Developed Spring

Synthesize every user, including children, how to use the spring development properly. This will prevent the system from becoming damaged and will save your community lots of money on parts and repairs.

Call benefiting community meeting and agree on the rules for how the developed spring should be used. The following is an example of some of the rules you should agree to:

- Always turn taps off
- Do not over tighten taps
- Do not let children play on or around the tap stand, spring box or reservoir

- Do not let animals near the tap stand, spring box or reservoir. Fence the entire area to prevent animals coming near.
- Do not allow clothes washing at the tap stand. This should be done away from the tap stand in a clothes washing area.
- Do not allow people to wash themselves at the tap stand. This should be done somewhere else.
- If the taps start to leak or other problems are identified, stop using it until the problem is identified and solved.

These are just some of the rules you should discuss with everyone. Make sure everyone understands and agrees to the rules.

3.7.4 Get the Community Involved

Maintaining the spring site is the responsibility of the WHOLE BENEFITING COMMUNITY, not just the caretakers. Your job is to organise the work, not do it all yourself!

Here are some ideas for how to organise the community:

- Call a community meeting and get everyone's view about how best to organise spring site maintenance and rules about spring development use.
- Divide the work of sweeping and scrubbing the apron amongst the women from different sections of the community on a rotating basis.
- Divide the work of weeding the site amongst the men from different sections of the community on a rotating basis.
- Get children involved in sweeping, scrubbing and weeding.

Organise a maintenance day at the end of the rainy season.

3.8 Preventive Maintenance

Preventive or routine maintenance involves tasks and activities carried out according to pre-established schedules to ensure the quality and reliability of operating facilities. It is based on rational considerations such as the manufacturer's recommendations for servicing equipment, industry standards and practices (which are based on collective experience), and the SSWP's own experience on the performance, durability, and reliability of the different equipment and their parts and components. Once established, these schedules need to be kept and the results recorded.

3.9 Unscheduled Maintenance

Unscheduled maintenance (also called Emergency or Repair maintenance) is a reactive intervention forced on the Utility when equipment, components, or parts either break down or malfunction. The activities and tasks are unplanned and generally unexpected, thus taking the nature of emergencies. They tend to be disruptive, inefficient, and often costly – not only to undertake but also in terms of lost revenues and goodwill. These occur most frequently when preventive maintenance has been poor or inadequate, after accidents and natural force majeure events, and when aging facilities are kept in service without replacement beyond their useful life.

All unscheduled maintenance situations need to be analyzed and the causes of the malfunction or breakage recorded. These records are important as they help in deciding whether part or all of a network or plant should be upgraded or replaced, and serve as a guide in future procurement decisions (for instance, sourcing of new equipment and of parts and supplies), as well as in related management decisions (e.g., inventory lists and levels).

3.10 Health and Environmental Requirements

3.10.1 Hygienic Operation and Use

The advantages of a well-maintained, safe supply of water can be drastically reduced if the collected water is not subsequently handled and used hygienically. The hygienic handling and use of water is an important part of O&M in its broadest sense.

Hygiene may be more important in the operation and maintenance of some systems than others. Users can follow simple agreed operational rules as shown by the following examples.

a) Use of an open well

To maintain the quality of open well water, the correct use of a bucket and rope lifting system is important. There are various combinations of lifting systems using communal or household buckets. Each system has its merits and drawbacks regarding hygiene. What is important in many cases is not so much the type of system but agreement by all users on how to operate it so that water quality can be preserved.

b) User operation of point water supply

Unsafe and insanitary conditions due to the careless handling of water at the standpost must be avoided. Typical rules that consumers and users agree on through consultation include :

Box 19: Typical hygienic rules for users

- ☞ wash hands and containers before collection
- ☞ avoid spillage, but if it does occur, direct all wastewater to the drainage channel
- ☞ do not leave taps open when there is no flow as water will be wasted and create insanitary pools when flow recommences
- ☞ do not leave taps running unattended
- ☞ do not drink water directly from the tap
- ☞ Do not allow cattle and other animals within the fenced area of the point water supply

The hygienic transport and use of water from the source to the point of final use is important for all supplies. For example, the coverage of containers during carrying and storage and the prevention of contamination through touching the collected water. Raising awareness of the need to take measures to safeguard water is an important part of community action. Hygienic operation and water use can be promoted by all O&M personnel. For example, a standpost caretaker's role often includes promoting the careful and hygienic use of taps.

3.10.2 Household Hygiene

Clean water is a key factor in keeping people health. A water source that is not protected, a dirty container, or unwashed hands can easily turn water, even water that looks and tastes clean, into something that makes people ill.

Even clean water collected from a source can be contaminated prior to use at critical points due to unsafe hygiene practices at household level.

- Transporting water from the source to the house in dirty water containers.
- Storing water at home in open and/or dirty water containers.
- Handling water at home with dirty utensils or hands

1) Water Fetching/Transport with Clean Containers

Containers, especially if they are narrowed neck-type, you are encouraged to clean them regularly with a soap solution, chemical disinfectant (if available), or pebbles.

2) Household Hygiene (water storage)

Safe water storage is the use of clean containers with covers AND good hygiene behaviors that prevent contamination during water collection, transport, and storage in the home.

Good hygiene in handling food is very important. However, it is also important to make sure that the dishes and utensils used for serving food are clean. If dishes and utensils are washed in dirty, greasy water they will be covered with many microbes. If they are dried with dirty cloth, they will collect more microbes.

Utensils that are clean and dry should be stored where pests and flies will not spread microbes on them. They can be stored on a drying rack and covered with a cloth. Utensils should not be left lying on the ground.

Use soap for washing dishes and utensils. If water supplies are limited, washing water does not have to be drinking water quality. However, always rinse dishes and utensils with safe water after washing. Avoid drying them with cloths. It is much better to make a simple drying rack so that dishes dry in the sun. Not only is this more hygienic but it saves time!

3.10.3 Environmental Hygiene

A water source can be contaminated through a number of routes including:

- Contaminated surface water run-off entering wells and springs.
- Collecting water with unwashed hands and/or dirty containers.
- Animals using the same source.

The following are some recommendations to keep water source always clean.



- Clean platform (apron, drainage and soakaway) and surrounding of the water scheme regularly
- If you find cracks in the platform, repair them.
- Keep animals away from the water scheme
- Sanitation facilities to be built at least away from 30 meters

Annexes



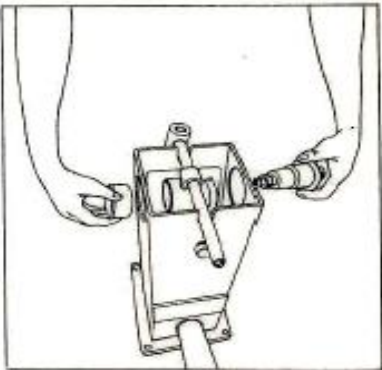

Annex A: Afridev Hand Pump Maintenance and Repair Sheet



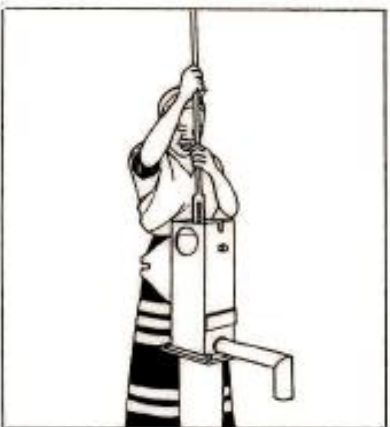

A) Maintenance and Repair Sheet-1

		
<p>1. Before starting, wash your hands and fill some buckets with clean water for cleaning parts.</p>	<p>2. Loosen the pump head cover bolt</p>	<p>3. Take off the cover</p>
		
<p>4. Loosen both hanger nuts</p>	<p>5. Loosen both fulcrum nuts</p>	<p>6. Put spanner through hanger eye</p>
		
<p>7. Raise and withdraw handle. Take care! As you remove the handle make sure the bush bearings and pin do not fall out as they may break on the floor.</p>	<p>8. Remove fulcrum pin and bush bearings.</p>	<p>9. Place all parts in cover for safe keeping</p>

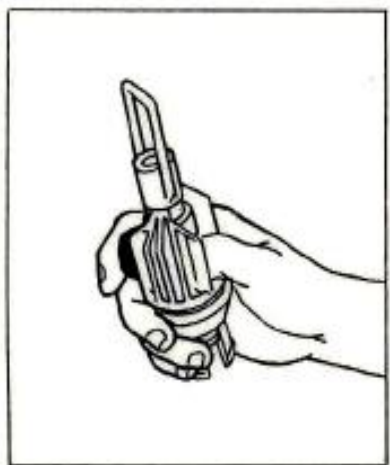

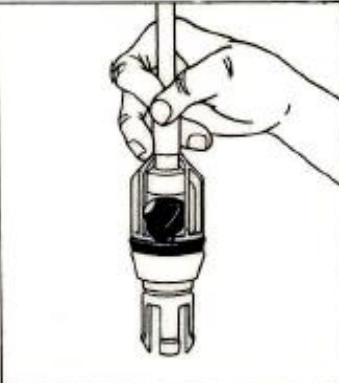
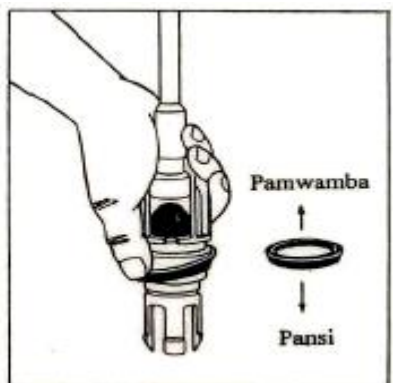
		
<p>10. Remove hanger pin and bush bearings</p>	<p>11. Pull up the hanger and first rod.</p>	<p>12. Slide the rubber centralizer where the rods join.</p>

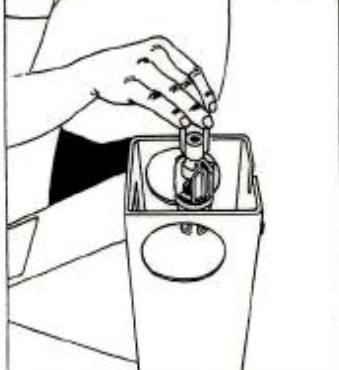
B) Maintenance and Repair Sheet-2

		
<p>13. Disconnect and remove all rods. Remember to keep the rods in the same order. The last rod taken out should be the first rod put back..</p>	<p>14. Remove the plunger</p>	<p>15. Lower the fishing tool and connect to the rods</p>
		
<p>16. Gently lower the last rod and hanger until you feel that you have caught the foot valve</p>	<p>17. Remove all the rods, the fishing tool and the foot valve</p>	<p>18. Push out the bobbin from the foot valve with your thumb. If the bobbin is damaged, replace it with a new one.</p>

		
<p>19. Remove the O-ring from the foot valve. If the O-ring is damaged, replace it with a new one</p>	<p>20. Push out the bobbin from the plunger with your thumb. If the bobbin is damaged, replace it with a new one</p>	<p>21. Carefully remove the U-seal. If it is damaged, replace it with a new one. Make sure the groove faces upwards</p>
		
<p>22. Wash the foot valve, plunger and rods. Use only clean water</p>	<p>23. To reassemble the pump, first drop the foot valve down the borehole. Make sure the hook is upwards</p>	<p>24. Put the plunger and pump rods back together and lower them down the borehole</p>

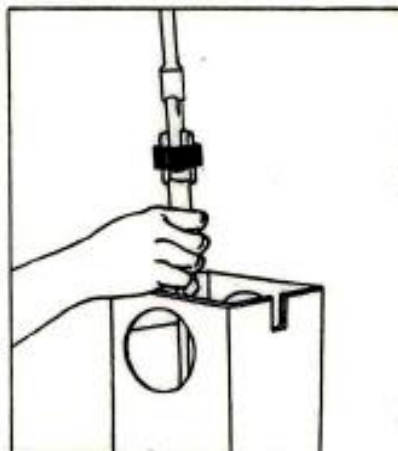
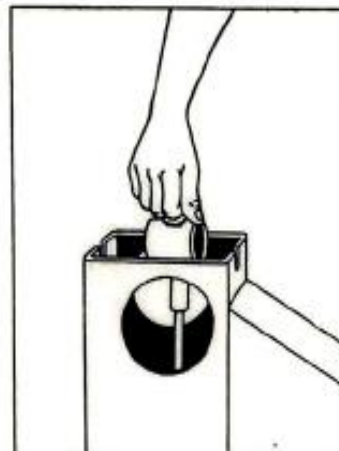
C) Maintenance and Repair Sheet-3

		
<p>25. Make sure the rubber centralizer is slid down over each joint on the pump rods.</p>	<p>26. Join all the rods together until the hanger rod is connected</p>	<p>27. Make sure the foot valve is in place by pushing the rods at arms length down the borehole.</p>

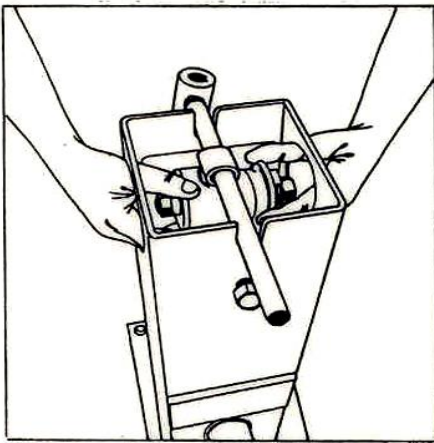

28. Put the spanner through the hanger eye to support the rods and then replace the hanger pin and bush bearings. If the bush bearings are worn out or damaged, replace them with new

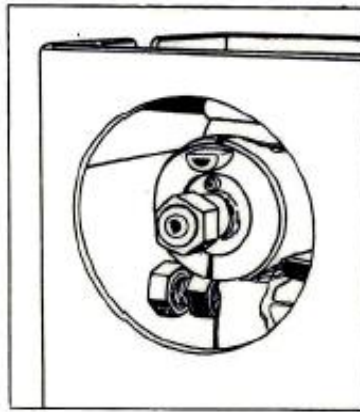

29. Turn the hanger pin and bush bearings so that the small projecting lugs are at the top

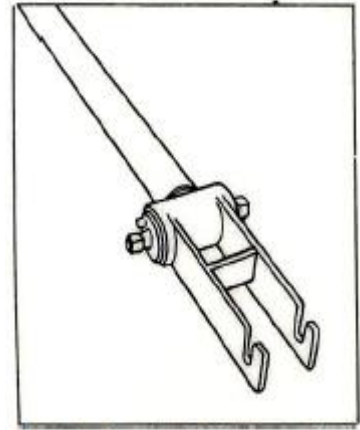

30. Put back the fulcrum pin and bush bearings in the handle. If the bush bearings are worn out or damaged, replace them with new ones.



31. Put the handle back

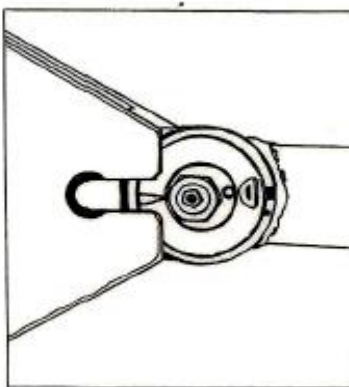

32. Make sure the projection lugs on the pin and bush bearings will fit into the slots on the pump body. Ensure that the pin is pushed right to the back of the slot.

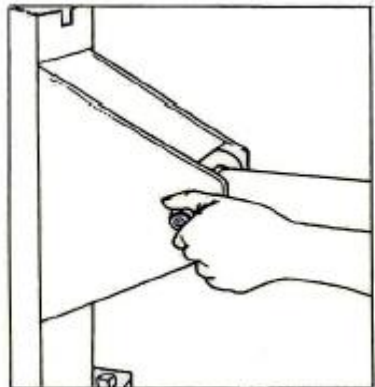

33. Tighten the fulcrum nuts by hand.

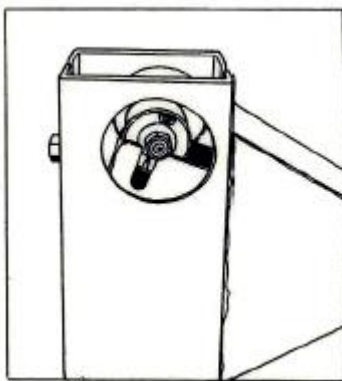

34. Push the handle down so that the slots engage in the hanger. Ensure that the hanger pin has slid to the bottom of the slots. Remove the spanner.

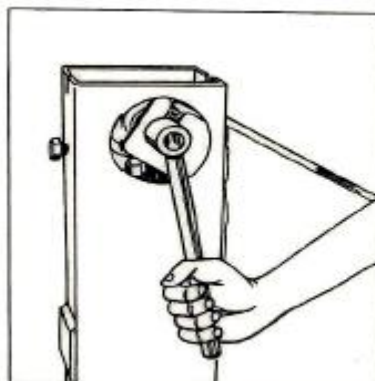

35. Tighten the hanger nuts with the spanner. Tighten alternatively on both sides



36. Tighten the fulcrum nuts with the spanner. Tighten alternatively on both sides.

D) Maintenance and Repair Sheet-4 (Re-assembling “Above Ground Components”)

		
<p>37. Put the cover back on</p>	<p>38. Tighten the cover nut</p>	<p>39. Pump water until clear water comes out before using for drinking</p>

Annex B: Weekly and monthly Inspections Sheet

Site Name		Caretaker Leader:		Pump Type:	Afridev		
Weekly							
Check Date	1. Working Condition			2. Is the surrounding of pump clean? (Yes/No)	3. Does pump handle work properly? (Yes/No)	4. Are bolts and nuts tightened? (Yes/No)	Remarks
	Check	In case of "non-functioning"					
		When stop	When repair				
	Functioning/ Non-functioning						
	Functioning/ Non-functioning						
	Functioning/ Non-functioning						
	Functioning/ Non-functioning						
	Functioning/ Non-functioning						



Monthly				
Check Date	1.Stroke Test	2.Buket Test	3.Chek Bering	Remarks
		How many times stroke to come up water	How many times stroke to fill up 20 liters	Worn out? (Yes/No)

Spare Parts Stock (In regard to the “rod centralizer, enter the number of rod in the bracket)

	U-seal	O-ring	Bobbin	Rod Centralizer	Bearing	Hanger	Fulcrum Pin
					bush	Pin	
For 1 year stock	2	1	1	4	8	0	0
Present stock							
Last replacement							
Next replacement							





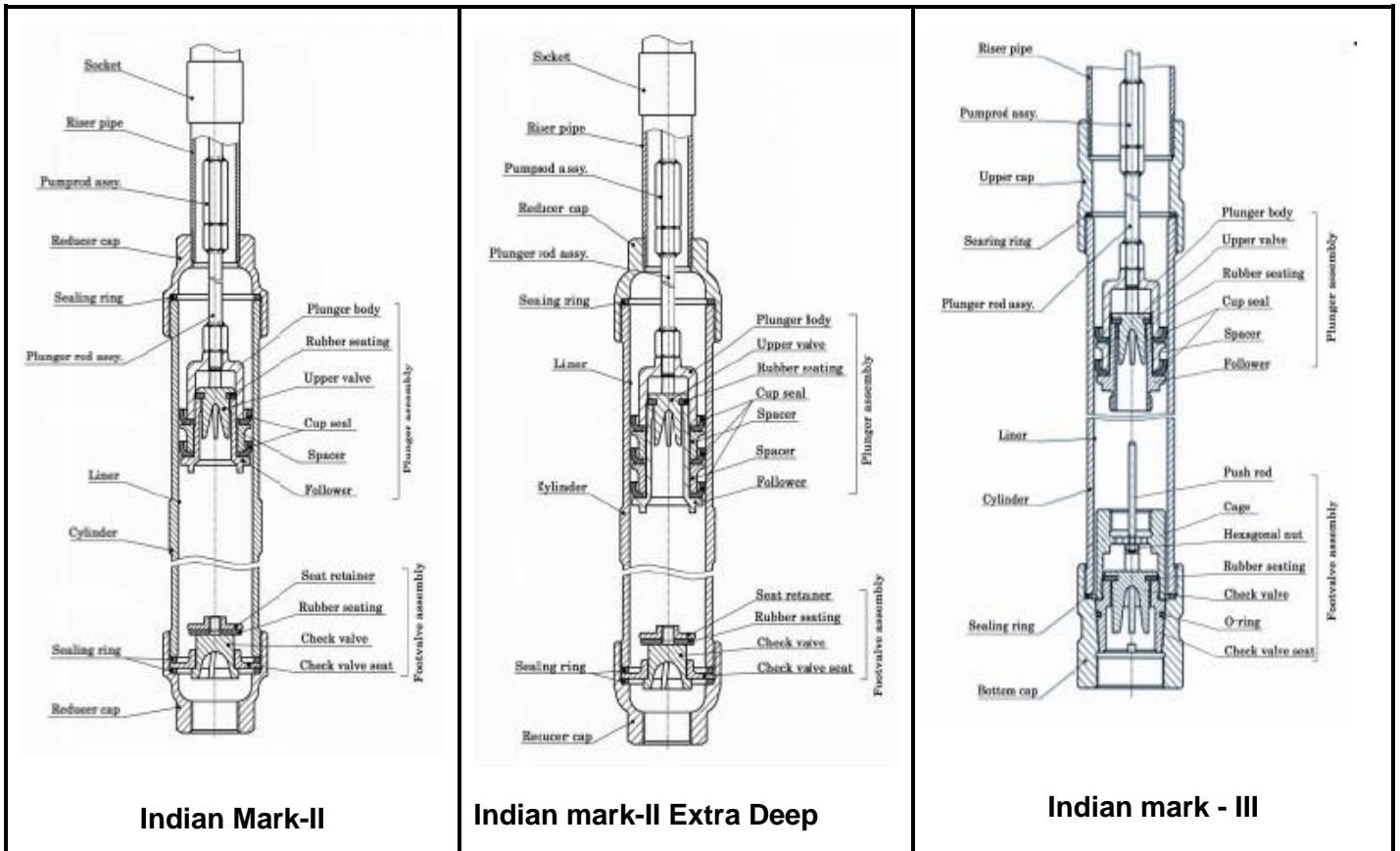



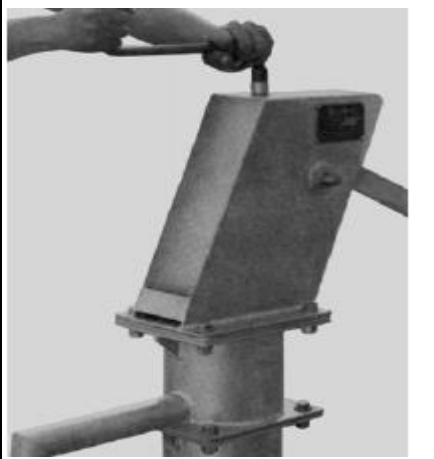

Annex D: Details of Indian Mark-II, Extra Deep and Mark-III

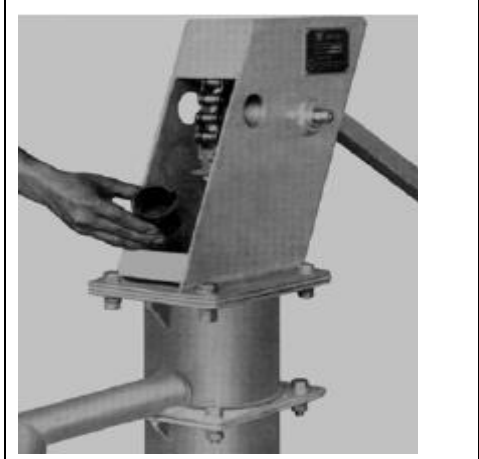

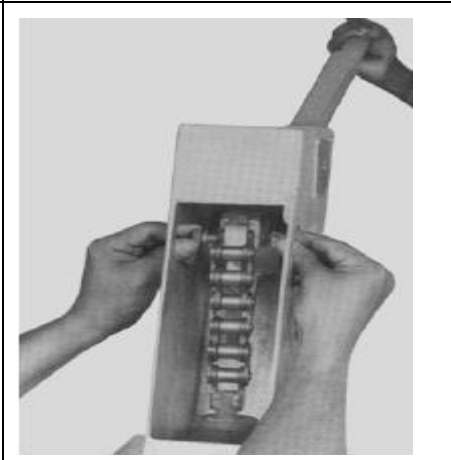
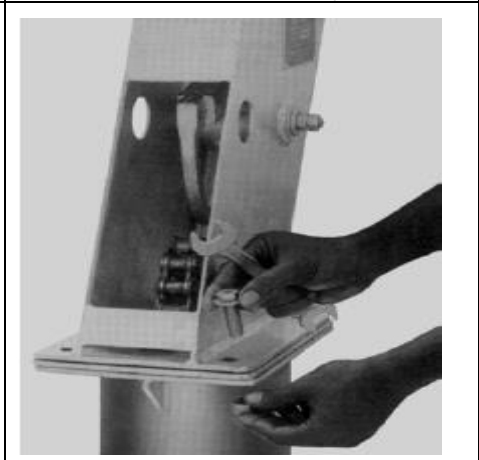
Annex E: Indian Mark-II Hand Pump Maintenance and Repair Sheet

a) Maintenance and Repair Sheet-1(Dismantling the “Above Ground Components”)

		
<p>1 Loosen Front cover bolt</p>	<p>2 Remove Front cover from Pump head</p>	<p>3 Lower Pump handle, put Chain below the Chain assembly</p>
		
<p>4 Lift Pump handle to top position and loosen “Nyloc” nut with spanners</p>	<p>5 Remove the “Nyloc” nut from bolt and remove Chain from the Handle</p>	<p>6 Loosen and remove bolts and nuts connecting Head and Water tank</p>
		
<p>7 Lift and remove Head assembly (chain passes hole in Head flange)</p>	<p>8 Lift Third plate with Pumprod assembly and insert Rod vice</p>	<p>9. Place Third plate on Rod vice, take off the Chain support and remove the Chain assembly</p>

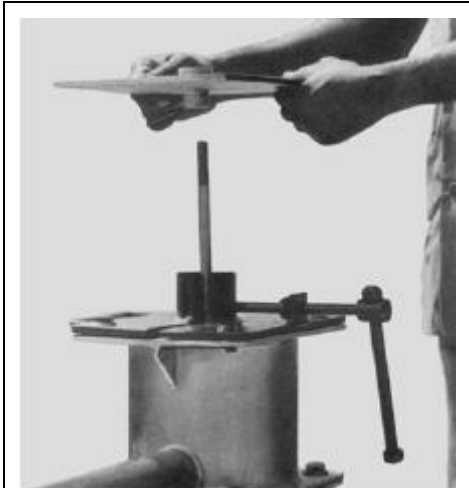

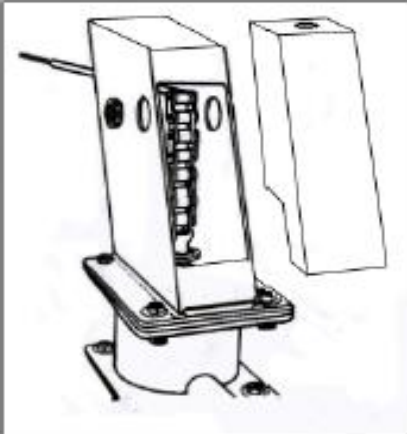
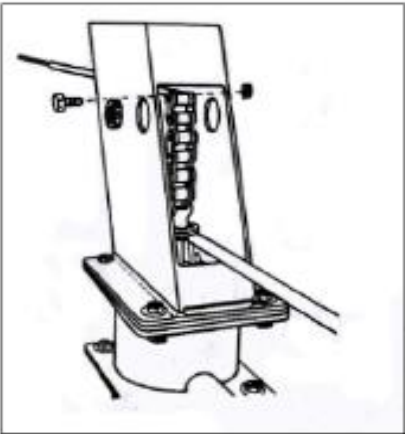
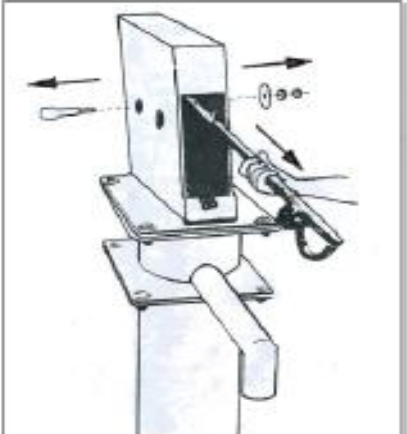
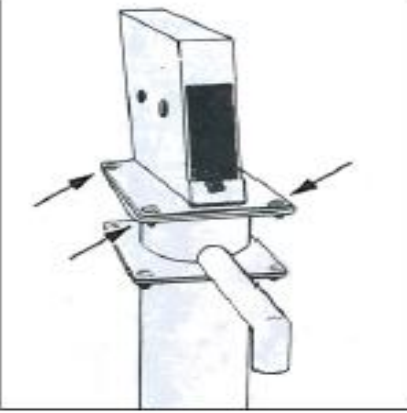
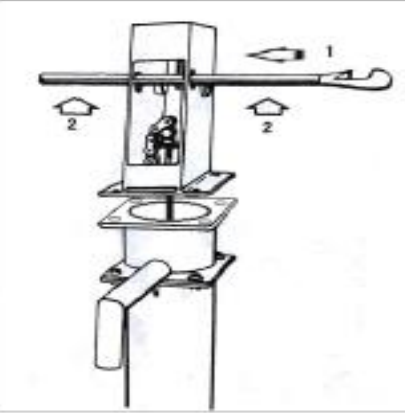
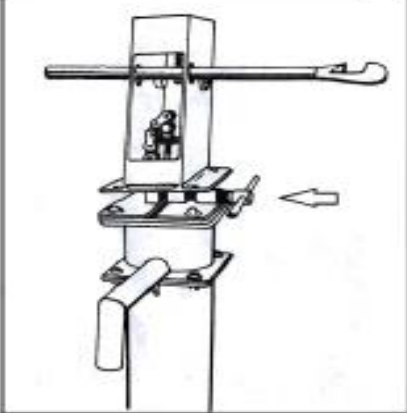
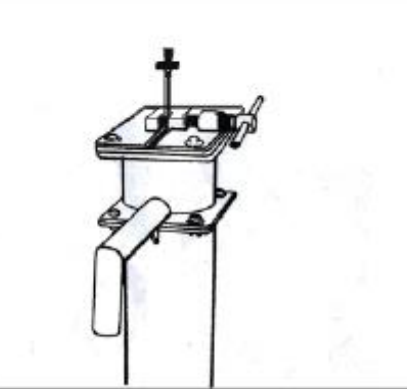
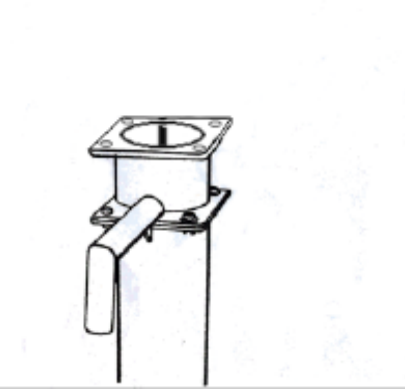
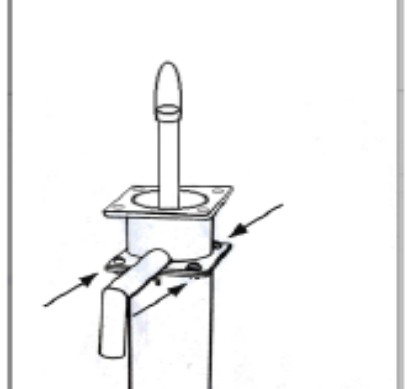

10 Unscrew check nut and remove Third plate assembly

b)

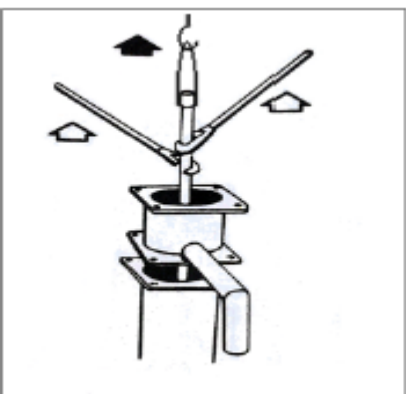
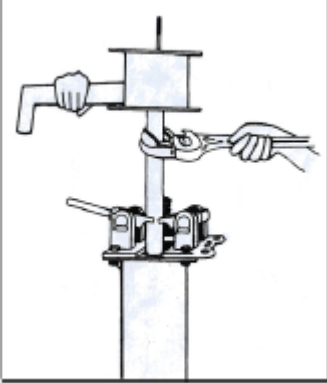
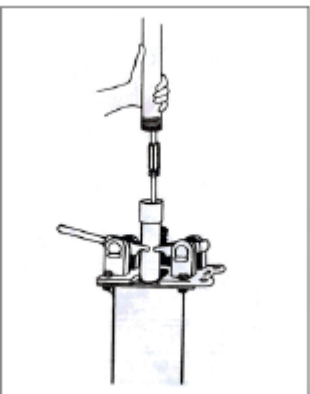
		
<p>1. Remove inspection cover from head assembly</p>	<p>2. Disconnect handle from chain by removing the lock nut and bolt</p>	<p>3. Take out handle-axle. While removing, use axle punch to protect axle thread and remove handle from head assembly.</p>
		
<p>4. Remove flange bolt from head assembly</p>	<p>5. Insert one pipe lifter into the holes provided in the head assembly and lift up</p>	<p>6. Fit the connecting rod vice onto the water chamber top flange</p>
		
<p>7. Remove chain & chain lock nut and remove head assembly</p>	<p>8. Support connecting rod with connecting rod lifter, loosen connecting rod vice and remove. Gently lower connecting rod. Remove connecting rod lifter</p>	<p>9. Remove water tank bottom flange bolts and set pipe lifter</p>

 <p>10. Lift water tank by using water tank lifter and pipe lifters or chain block</p>	 <p>11. Fit self locking clamp or clamp and remove water tank</p>	 <p>12. Disassemble rising main and connecting rods. Remove connecting rod lengths, one at time</p>
---	--	--

Maintenance and Repair Sheet-1(Dismantling the “below Ground Components”)

 <p>1 Attach Rod lifter to Top rod, hold Rod lifter and remove Rod vice</p>	 <p>2 Lift Pumprod assembly by hand until next connection is about 30 cm above the Water tank. Introduce Rod vice and clamp Pumprod securely in this position</p>	 <p>3 Open the connection with two spanners and remove the rod</p>



7 Lift and remove Head assembly (chain passes hole in Head flange)



8 Lift Third plate with Pumprod assembly and insert Rod vice

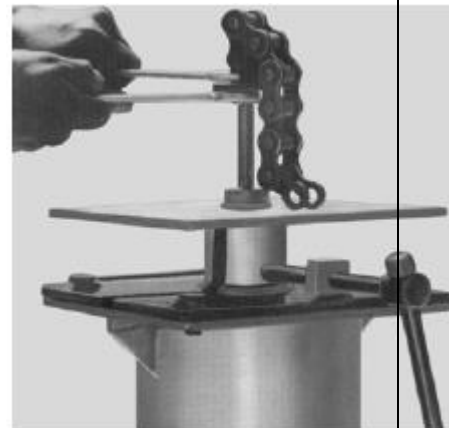

9. Place Third plate on Rod vice, take off the Chain support and remove the Chain assembly



10 Unscrew check nut and remove Third plate assembly

c) Maintenance and Repair Sheet-2



13. While removing the pipes and rods, ensure that you place these on the pipe stands. Continue doing so until the entire below-ground assembly has been removed from the tube-well

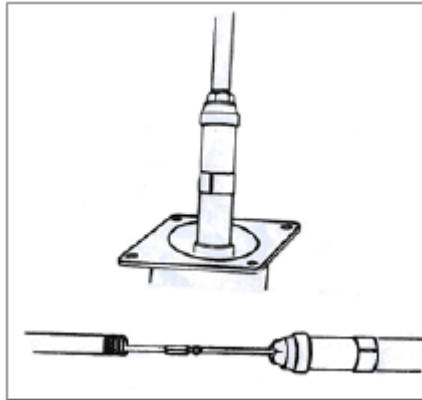

14. Disconnect cylinder from the last pipe



15. Check all the pipe thread; clean out the threads by using wire brush. Remove any dirt and rust from the pipes by using wire brush or sandpaper. If any pipe is damaged, replace. Ensure that all pipe couplings are intact and fit properly

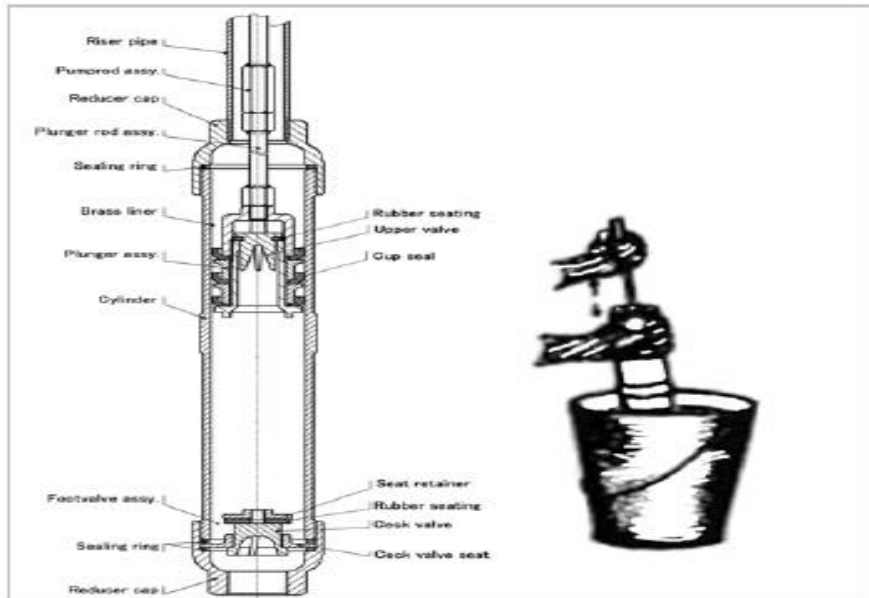

16. Open cylinder with the help of pipe wrenches and check that plunger and footvalve are tight and properly assembled. Test cylinder in a bucket of water. If check-valve leaks replace it.

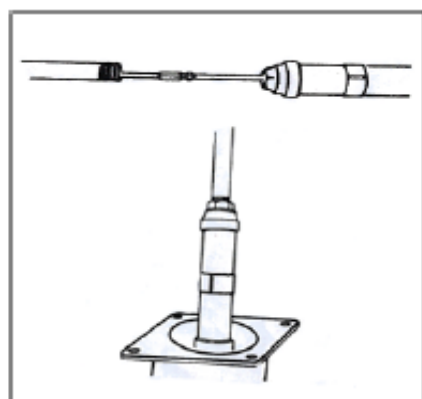

17. Joint first connecting rod to plunger rod. Screw first pipe into cylinder. Lower cylinder

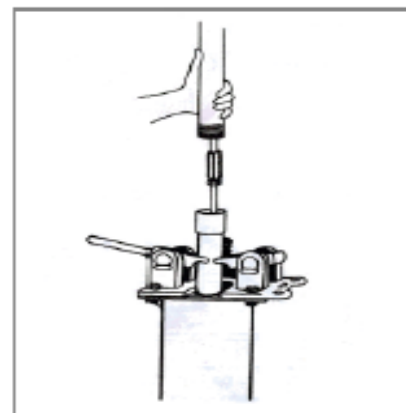

18. Lower pipe and connecting rod into tube-well using pipe lifters/chain block and clamp with self-locking clamp. Continue to last pipe

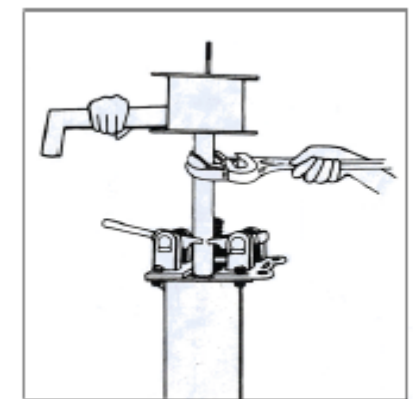

19. Screw water tank to last pipe. Tighten fully

d) Maintenance and Repair Sheet-3

<p>20. Remove clamp. Carefully lower water tank on to pedestal with the pipe lifters or chain block. Spout must face drain</p>	<p>21. Bolt and fit check nuts</p>	<p>22. Fit the connecting rod vice onto the water chamber top flange</p>
<p>23. Screw chain onto rod. Use two spanners-tighten check nut fully against chain coupling</p>	<p>24. Remove rod clamp. Lower head onto water tank. Bolt and fit check nuts</p>	<p>25. Insert handle through head. Adjust handle, then insert axle. Tap lightly, but do not use</p>
<p>26. Fit chain to handle</p>	<p>27. Fix inspection cover on the head</p>	<p>30. Put back the fulcrum pin and bush bearings in the handle. If the bush bearings are worn out or damaged, replace them with new ones</p>

e) Maintenance and Repair Sheet-4 (Special Installation & Maintenance Kit)

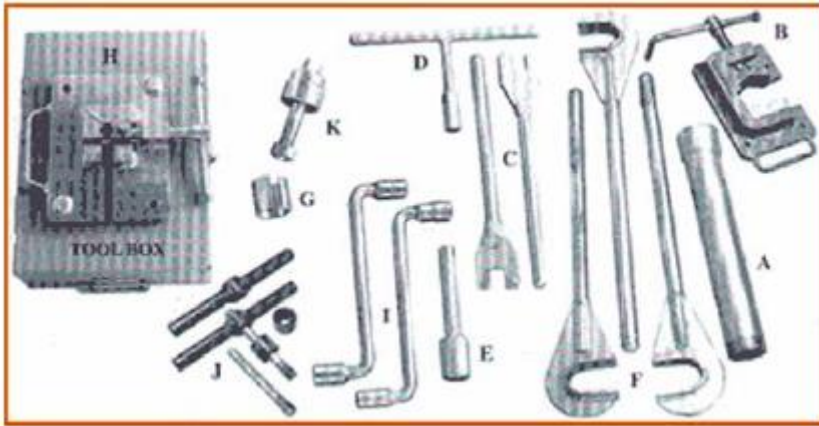

Annex F: Monthly check sheet for spring Type-1

Site Name:	Caretaker leader:
------------	-------------------

Date	Facility	Work condition		Crack (Yes/No)	Leak/ Broken (Yes/No)	Wet ground (Yes/No)	Clean in/outside (Yes/No)	Drainage OK? (Yes/No)	Over flow OK? (Yes/No)	Pipe OK? (Yes/No)	Valve? (Yes/No)	Remarks	
		Check	In case of "non-functioning"										
			When stop										When repair
	Spring Box	Functioning/No n-functioning											
	Tap	Functioning/No n-functioning											
	Spring Box	Functioning/No n-functioning											
	Tap	Functioning/No n-functioning											
	Spring Box	Functioning/No n-functioning											
	Tap	Functioning/No n-functioning											
	Spring Box	Functioning/No n-functioning											
	Tapstand	Functioning/No n-functioning											
	Spring Box	Functioning/No n-functioning											
	Tap	Functioning/No n-functioning											
	Spring Box	Functioning/No n-functioning											
	Tap	Functioning/No n-functioning											



Annex G: Monthly check sheet for spring Type-2

Site Name:	Caretaker leader:
------------	-------------------

Date	Facility	Work condition		Crack (Yes/No)	Leak/ Broken (Yes/No)	Wet ground (Yes/No)	Clean in/outside (Yes/No)	Drainage OK? (Yes/No)	Over flow OK? (Yes/No)	Pipe OK? (Yes/No)	Valve? (Yes/No)	Remarks	
		Check	In case of 'non-functioning'										
			When stop										When repair
	Spring Box	Functioning /Non-											
	Tapstand No.1	Functioning /Non-											
	Tapstand No.2	Functioning /Non-											
	Spring Box	Functioning /Non-											
	Tapstand No.1	Functioning /Non-											
	Tapstand No.2	Functioning /Non-											
	Spring Box	Functioning /Non-											
	Tapstand No.1	Functioning /Non-											
	Tapstand No.2	Functioning /Non-											
	Spring Box	Functioning /Non-											
	Tapstand No.1	Functioning /Non-											
	Tapstand No.2	Functioning /Non-											
	Spring Box	Functioning /Non-											
	Tapstand No.1	Functioning /Non-											
	Tapstand No.2	Functioning /Non-											



Annex H: Monthly check sheet for spring Type-3

Site Name:	Caretaker leader:
------------	-------------------

Date	Facility	Work condition		Crack (Yes/No)	Leak/ Broken (Yes/No)	Wet ground (Yes/No)	Clean in/outside (Yes/No)	Drainage OK? (Yes/No)	Over flow OK? (Yes/No)	Pipe OK? (Yes/No)	Valve? (Yes/No)	Remarks	
		Check	In case of "non-functioning"										
			When stop										When repair
	Spring Box	Functioning /Non-functioning											
	Reservoir	Functioning /Non-functioning											
	Tapstand No.1	Functioning /Non-functioning											
	Tapstand No.2	Functioning /Non-functioning											
	Spring Box	Functioning /Non-functioning											
	Reservoir	Functioning /Non-functioning											
	Tapstand No.1	Functioning /Non-functioning											
	Tapstand No.2	Functioning /Non-functioning											
	Spring Box	Functioning /Non-functioning											
	Reservoir	Functioning /Non-functioning											
	Tapstand No.1	Functioning /Non-functioning											
	Tapstand No.2	Functioning /Non-functioning											
	Spring Box	Functioning /Non-functioning											
	Reservoir	Functioning /Non-functioning											
	Tapstand No.1	Functioning /Non-functioning											
	Tapstand No.2	Functioning /Non-functioning											



